

**TECHNO VENEERS**

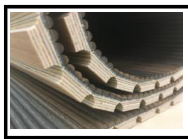

**Rigid and Flexible panels**



**S3 P5**



**S3 P7,5**



**S3 P10**



**S3 P15**



**S3 P20**

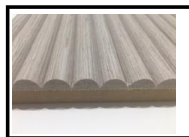

**S6 P13**



**S6 P10**

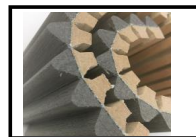

**S10 P15**

**Rigid panels**



**WAVE P30**



**WAVE P22**



**WAVE P8**

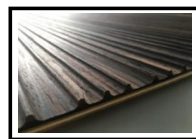

**WAVE P12|19**



**MILLED P4F04**



**MILLED P6F06**



**MILLED P4|6|8|12**



**WAVE P25**



**WAVE P20**

---

TECHNO VENEERS

Specifications

An incredible variety of different finishes and combinations for the creation of contemporary, unique and refined environments. The panels are in fact available in 2 types of support (MDF panel and multilayer panel), 3 finish thicknesses (3mm - 6mm - 10mm) and in 8 types of wood/reconstituted wood

**Inner core**

Standard MDF panel CARB2  
Waterproof MDF panel CARB2  
Fireproof MDF panel CARB2  
Black MDF panel  
Multi-layer panel

**Standard Sizes**

1200x1800 mm  
Flexible panels  
3000x1200 mm  
Rigid and Flexible panels

**Finishes**

Wood or Reconstituted veneer

# TECHNO VENEERS\_RIGID and FLEXIBLE PANELS

## S3 P5

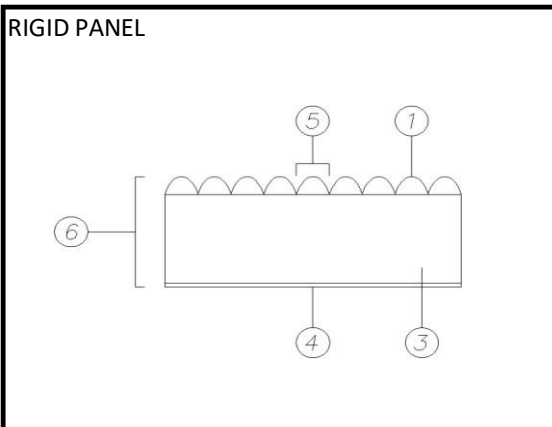

1 **3 mm**  
Finish thickness

2 **0,5 mm**  
Fabric

3 **15 mm RIGID SUPPORT**  
MDF panel / Multi-layer panel

3 **5 mm FLEXIBLE SUPPORT**  
MDF panel / Multi-layer panel

4 **0,6 mm**  
Balancing material

5 **5 mm**  
Mills spacing

6 **19 mm RIGID PANEL**  
**9 mm FLEXIBLE PANEL**  
Finished thickness

**3000x1200 mm**  
**1200x1800 mm**

**RIGID PANEL**  
**FLEXIBLE PANEL**

**3000x1200 mm**  
Standard sizes

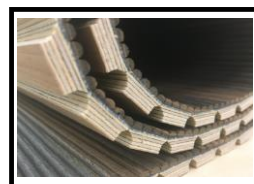
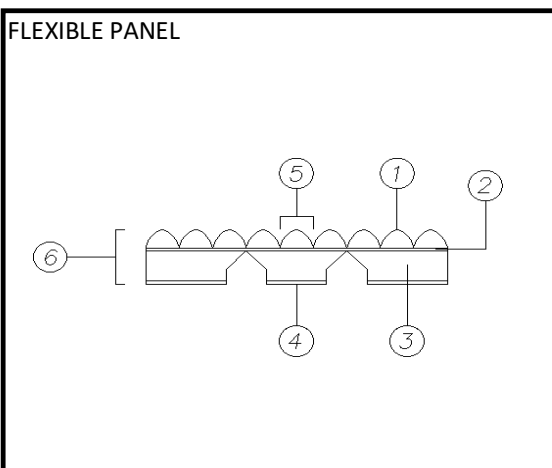

# TECHNO VENEERS\_RIGID and FLEXIBLE PANELS

## S3 P7,5

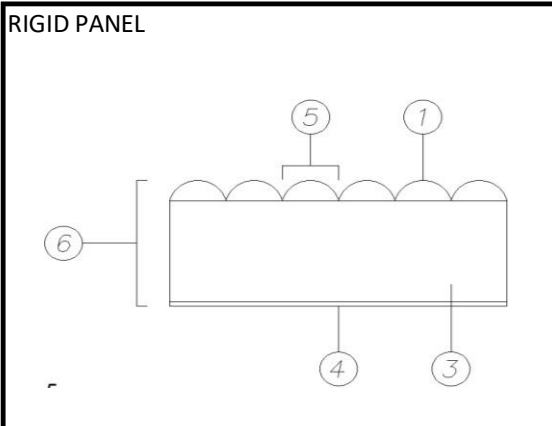

**1** 3 mm  
Finish thickness

**2** 0,5 mm  
Fabric

**3** 15 mm **SUPPORTO RIGIDO**  
MDF panel / Multi-layer panel

**3** 5 mm **SUPPORTO FLESSIBILE**  
MDF panel / Multi-layer panel

**4** 0,6 mm  
Balancing material

**5** 7,5 mm  
Mills spacing

**6** 19 mm **PANNELLO RIGIDO**  
9 mm **PANNELLO FLESSIBILE**  
Finished thickness

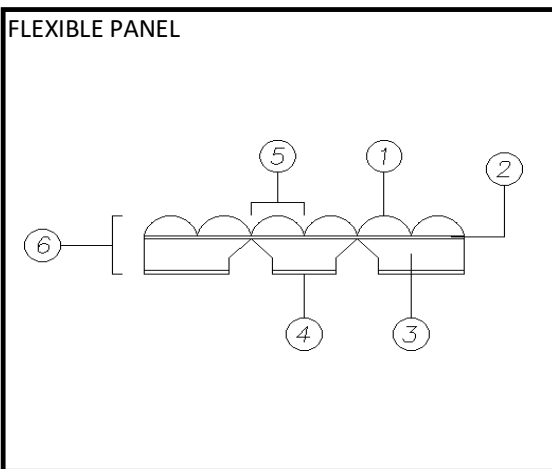

**3000x1200 mm**                      **RIGID PANEL**  
**1200x1800 mm**                      **FLEXIBLE PANEL**  
**3000x1200 mm**  
Standard sizes

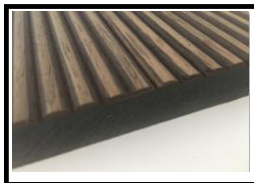
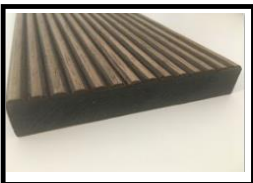

# TECHNO VENEERS\_RIGID and FLEXIBLE PANELS

## S3 P10

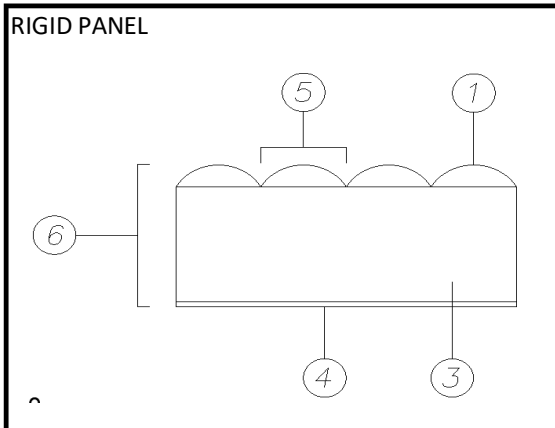

1 **3 mm**  
Finish thickness

2 **0,5 mm**  
Fabric

3 **15 mm SUPPORTO RIGIDO**  
MDF panel / Multi-layer panel

3 **5 mm SUPPORTO FLESSIBILE**  
MDF panel / Multi-layer panel

4 **0,6 mm**  
Balancing material

5 **10 mm**  
Mills spacing

6 **19 mm PANNELLO RIGIDO**  
**9 mm PANNELLO FLESSIBILE**  
Finished thickness

**3000x1200 mm**                      **RIGID PANEL**  
**1200x1800 mm**  
**3000x1200 mm**                      **FLEXIBLE PANEL**  
Standard sizes

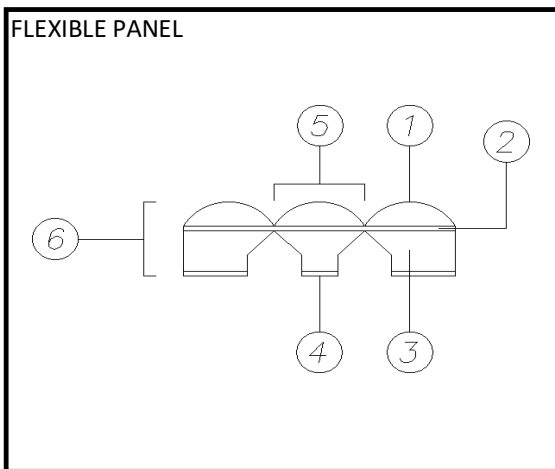

# TECHNO VENEERS\_RIGID and FLEXIBLE PANELS

## S3 P15

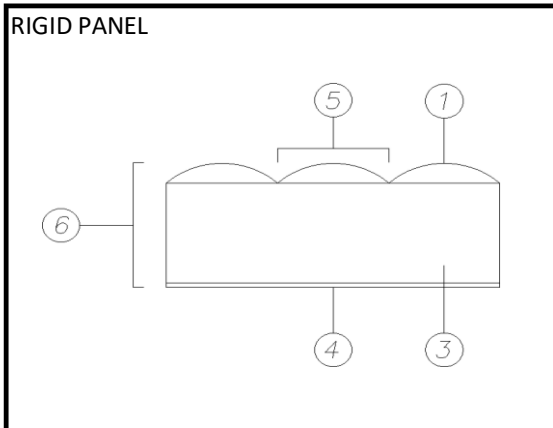

**1 3 mm**  
Finish thickness

**2 0,5 mm**  
Fabric

**3 15 mm SUPPORTO RIGIDO**  
MDF panel / Multi-layer panel

**3 5 mm SUPPORTO FLESSIBILE**  
MDF panel / Multi-layer panel

**4 0,6 mm**  
Balancing material

**5 15 mm**  
Mills spacing

**6 19 mm PANNELLO RIGIDO**  
**9 mm PANNELLO FLESSIBILE**  
Finished thickness

<b>3000x1200 mm</b>	<b>RIGID PANEL</b>
<b>1200x1800 mm</b>	<b>FLEXIBLE PANEL</b>
<b>3000x1200 mm</b>	
Standard sizes	

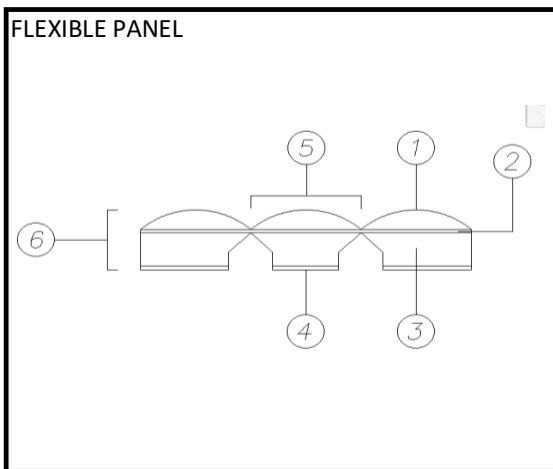

# TECHNO VENEERS\_RIGID and FLEXIBLE PANELS

## S3 P20

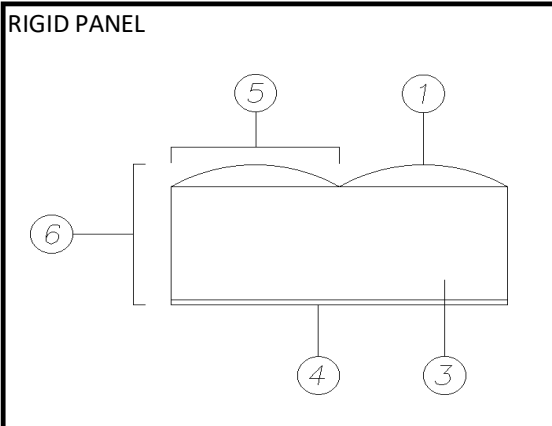

**1** 3 mm  
Finish thickness

**2** 0,5 mm  
Fabric

**3** 15 mm **SUPPORTO RIGIDO**  
MDF panel / Multi-layer panel

**3** 5 mm **SUPPORTO FLESSIBILE**  
MDF panel / Multi-layer panel

**4** 0,6 mm  
Balancing material

**5** 15 mm  
Mills spacing

**6** 19 mm **PANNELLO RIGIDO**  
9 mm **PANNELLO FLESSIBILE**  
Finished thickness

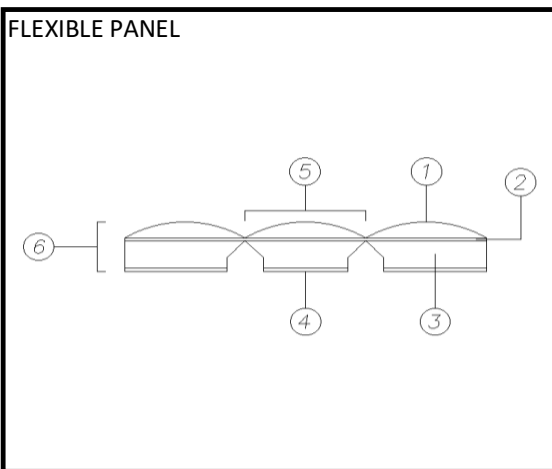

**3000x1200 mm**                      **RIGID PANEL**  
**1200x1800 mm**  
**3000x1200 mm**                      **FLEXIBLE PANEL**  
Standard sizes



# TECHNO VENEERS\_RIGID and FLEXIBLE PANELS

## S6 P13

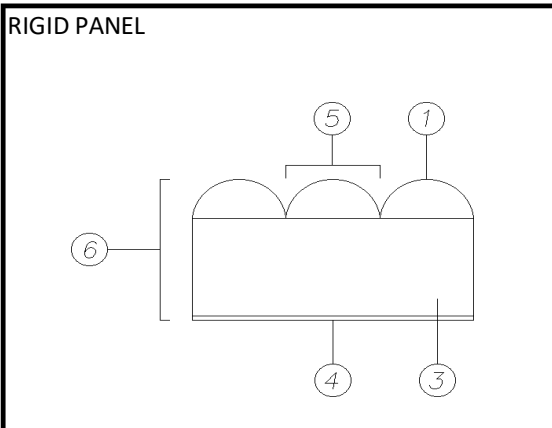

**1** 6 mm  
Finish thickness

**2** 0,5 mm  
Fabric

**3** 15 mm **SUPPORTO RIGIDO**  
MDF panel / Multi-layer panel

**3** 5 mm **SUPPORTO FLESSIBILE**  
MDF panel / Multi-layer panel

**4** 0,6 mm  
Balancing material

**5** 13 mm  
Mills spacing

**6** 22 mm **PANNELLO RIGIDO**  
12 mm **PANNELLO FLESSIBILE**  
Finished thickness

<b>3000x1200 mm</b>	<b>RIGID PANEL</b>
<b>1200x1800 mm</b>	
<b>3000x1200 mm</b>	<b>FLEXIBLE PANEL</b>
Standard sizes	

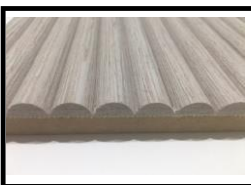
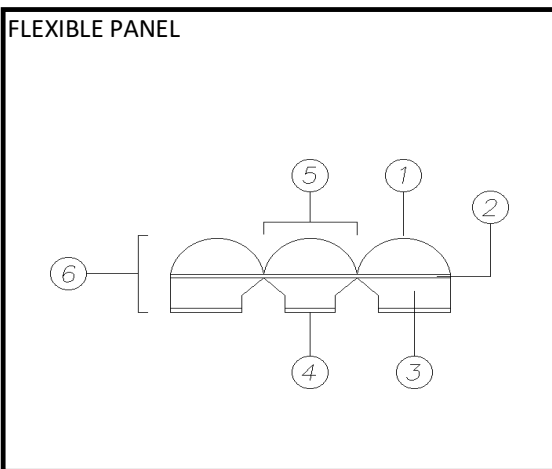



# TECHNO VENEERS\_RIGID and FLEXIBLE PANELS

## S6 P10

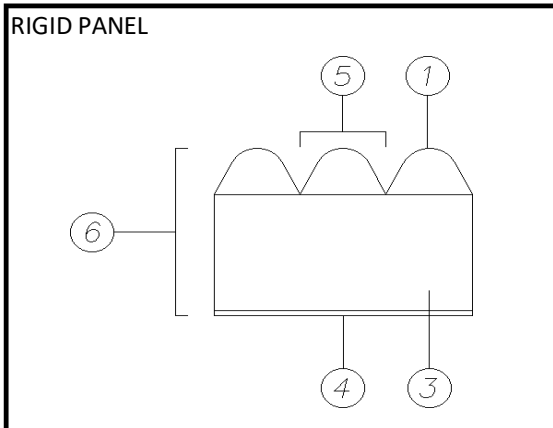

**1** 6 mm  
Finish thickness

**2** 0,5 mm  
Fabric

**3** 15 mm **SUPPORTO RIGIDO**  
MDF panel / Multi-layer panel

**3** 5 mm **SUPPORTO FLESSIBILE**  
MDF panel / Multi-layer panel

**4** 0,6 mm  
Balancing material

**5** 10 mm  
Mills spacing

**6** 22 mm **PANNELLO RIGIDO**  
12 mm **PANNELLO FLESSIBILE**  
Finished thickness

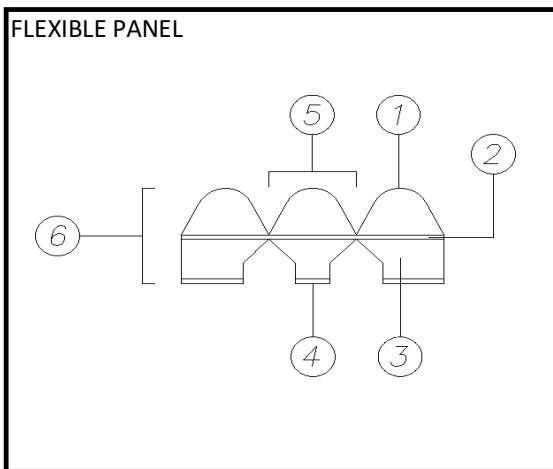

**3000x1200 mm**                      **RIGID PANEL**  
**1200x1800 mm**  
**3000x1200 mm**                      **FLEXIBLE PANEL**  
Standard sizes

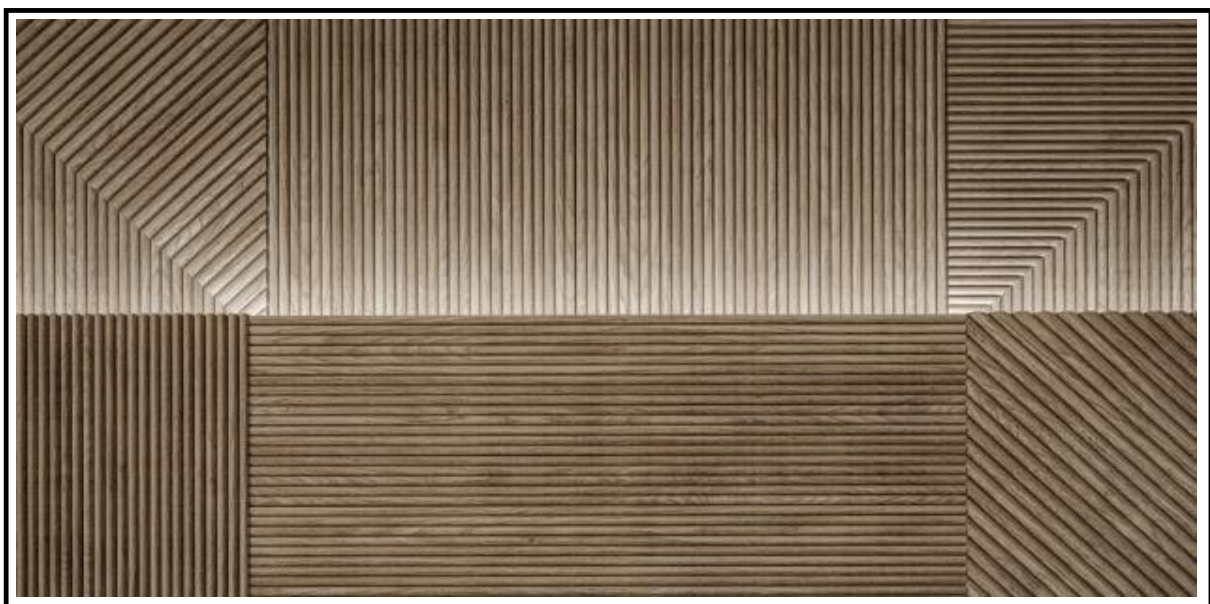
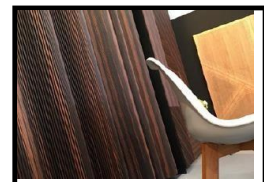
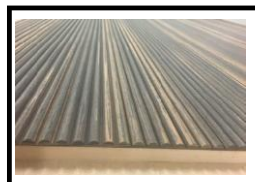

# TECHNO VENEERS\_RIGID and FLEXIBLE PANELS

## S10 P15

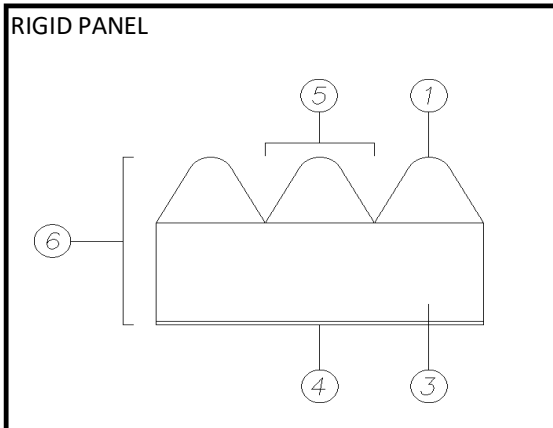

**1** 10 mm  
Finish thickness

**2** 0,5 mm  
Fabric

**3** 15 mm **SUPPORTO RIGIDO**  
MDF panel / Multi-layer panel

**3** 5 mm **SUPPORTO FLESSIBILE**  
MDF panel / Multi-layer panel

**4** 0,6 mm  
Balancing material

**5** 15 mm  
Mills spacing

**6** 25 mm **PANNELLO RIGIDO**  
15 mm **PANNELLO FLESSIBILE**  
Finished thickness

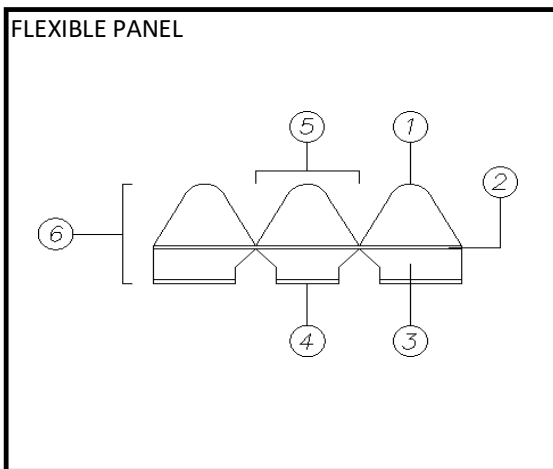

**3000x1200 mm** **RIGID PANEL**

**1200x1800 mm** **FLEXIBLE PANEL**

**3000x1200 mm**

Standard sizes

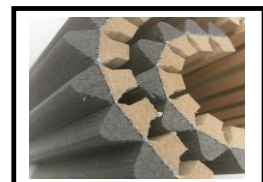
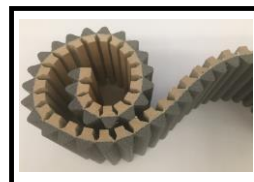

# TECHNO VENEERS\_RIGID PANELS WAVE P30

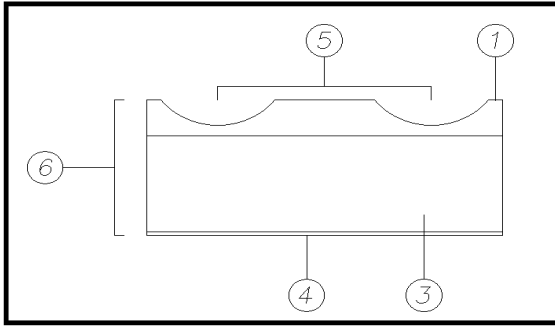

- 1 6 mm**  
Finish thickness
  - 3 15 mm**  
MDF panel / Multi-layer panel
  - 4 0,6 mm**  
Balancing material
  - 5 30 mm**  
Mills spacing
  - 6 22 mm**  
Finished thickness
- 
- 3000x1200 mm**  
Standard sizes

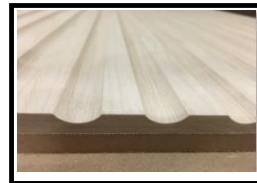

# TECHNO VENEERS\_RIGID PANELS

## WAVE P22

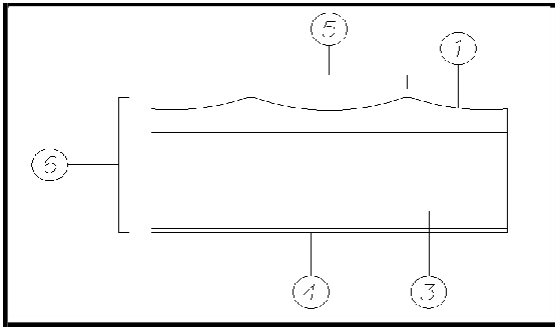

- 1 6 mm**  
Finish thickness
  - 3 15 mm**  
MDF panel / Multi-layer panel
  - 4 0,6 mm**  
Balancing material
  - 5 22 mm**  
Mills spacing
  - 6 22 mm**  
Finished thickness
- 
- 3000x1200 mm**  
Standard sizes



# TECHNO VENEERS\_RIGID PANELS WAVE P8

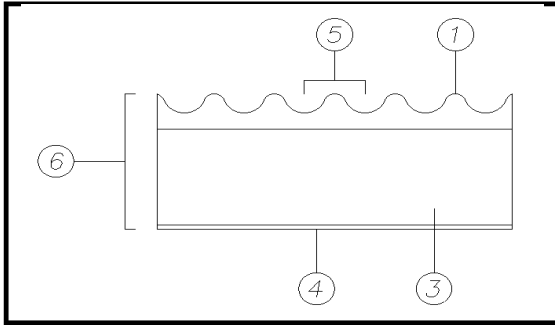

- 1 6 mm**  
Finish thickness
  - 3 15 mm**  
MDF panel / Multi-layer panel
  - 4 0,6 mm**  
Balancing material
  - 5 8,5 mm**  
Mills spacing
  - 6 22 mm**  
Finished thickness
- 
- 3000x1200 mm**  
Standard sizes



# TECHNO VENEERS\_RIGID PANELS WAVE P12 | 19

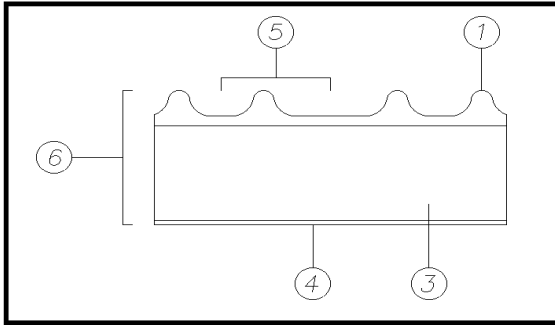

- 1 6 mm**  
Finish thickness
- 3 15 mm**  
MDF panel / Multi-layer panel
- 4 0,6 mm**  
Balancing material
- 5 12 | 19 mm**  
Mills spacing
- 6 22 mm**  
Finished thickness

**3000x1200 mm**  
Standard sizes

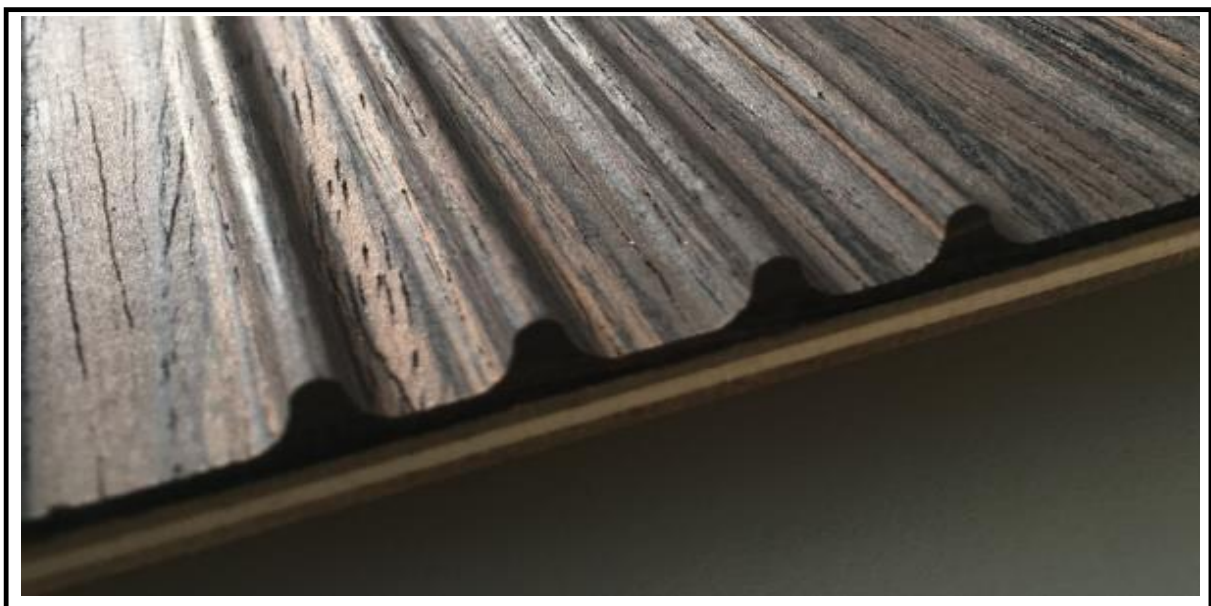

# TECHNO VENEERS\_RIGID PANELS MILLED P4 F04

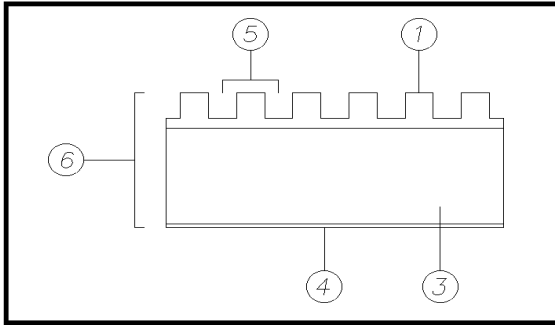

- 1 6 mm**  
Finish thickness

---

- 3 15 mm**  
MDF panel / Multi-layer panel

---

- 4 0,6 mm**  
Balancing material

---

- 5 8 mm**  
Mills spacing

---

- 6 22 mm**  
Finished thickness

---

- 3000x1200 mm**  
Standard sizes



# TECHNO VENEERS\_RIGID PANELS MILLED P6 F06

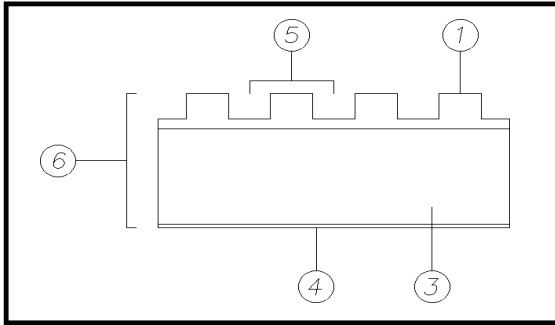

- 1 6 mm**  
Finish thickness

---

- 3 15 mm**  
MDF panel / Multi-layer panel

---

- 4 0,6 mm**  
Balancing material

---

- 5 12 mm**  
Mills spacing

---

- 6 22 mm**  
Finished thickness

**3000x1200 mm**  
Standard sizes





# TECHNO VENEERS\_RIGID PANELS MILLED P4|6|8|12

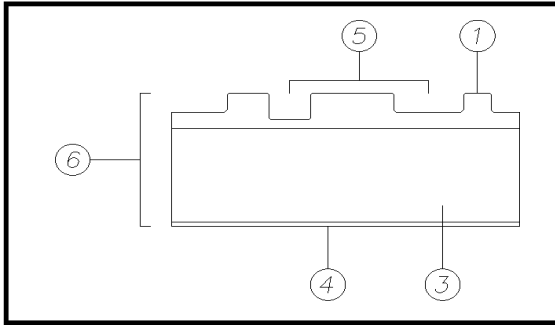

- 1 6 mm**  
Finish thickness
- 2 6 mm**  
Finish thickness
- 3 15 mm**  
MDF panel / Multi-layer panel
- 4 0,6 mm**  
Balancing material
- 5 4|6|8|12**  
Mills spacing
- 6 22 mm**  
Finished thickness

**3000x1200 mm**  
Standard sizes

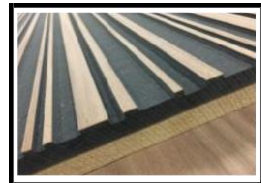

# TECHNO VENEERS\_RIGID PANELS WAVE P25

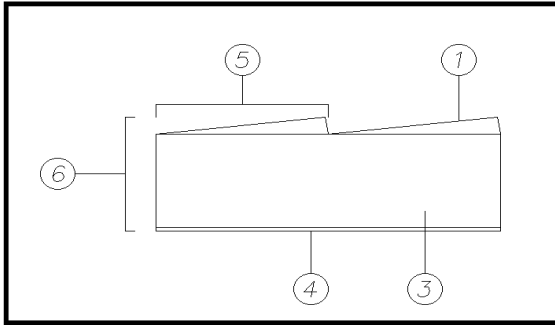

- 1 3 mm**  
Finish thickness

---

- 3 15 mm**  
MDF panel / Multi-layer panel

---

- 4 0,6 mm**  
Balancing material

---

- 5 19 mm**  
Mills spacing

---

- 6 18,4 mm**  
Finished thickness

**3000x1200 mm**  
Standard sizes



# TECHNO VENEERS\_RIGID PANELS WAVE P20

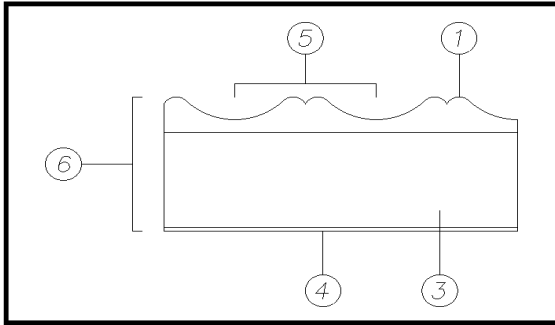

- 1 6 mm**  
Finish thickness
- 3 15 mm**  
MDF panel / Multi-layer panel
- 4 0,6 mm**  
Balancing material
- 5 20 mm**  
Mills spacing
- 6 22 mm**  
Finished thickness

**3000x1200 mm**  
Standard sizes

