

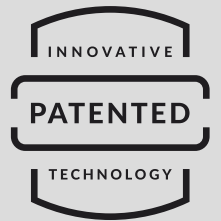

# EasyClick system



# components

## EASYCLICK SYSTEM UNDERSTRUCTURE



## IDECKING REVOLUTION BOARDS - DETAILS

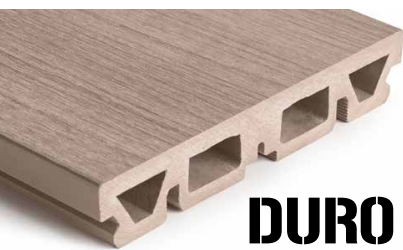

**DURO**

Duro boards are made from circa 50% RICE HUSK and 50% virgin PVC and Minerals in order to deliver a product with as natural a look and feel as possible. As it happens for wood, Duro composite material can encounter a slight chromatic change due to UV rays. After only a few months the boards will stop further chromatic change and become colour fast. For covered or partially shaded areas this process will take longer. Using our specific products (Duro Shield and Duro Drop) it is possible to protect Duro's look from stains and slow down the rate of fade. Furniture like flower boxes can also cause colour change to the deck area so it is advised to change the position of this furniture during the first 3-6 months in order to maximum colour compensation.



ETHERNO

Minimal changes in colour and tone underline the natural aspect of EthernO Bamboo, just like in any other noble wood (ie. IPE / TEAK). Colour variations, like profile and surface alterations, are normal in the natural behaviour of any wood and don't represent vices or defects in the product so are not cause of a claim. In order to get uniformity over the deck area, it is advised to mix up the boards before installation.

just 1 click and the board is installed !



# technical data on the system

**EasyClick board standard width  
140mm + 4 mm gap**

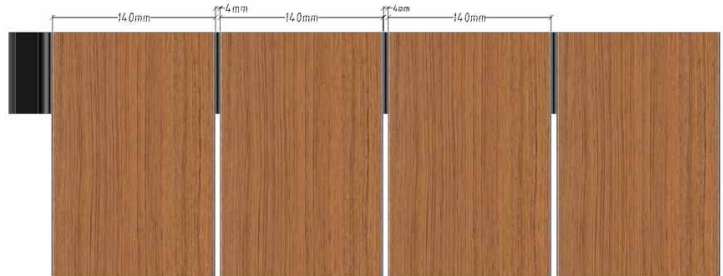

**Total Height of DURO Boards +  
EasyClick Understructure: 53 mm**



**Total Height of ETHERNO boards +  
EasyClick Understructure: 47 mm**

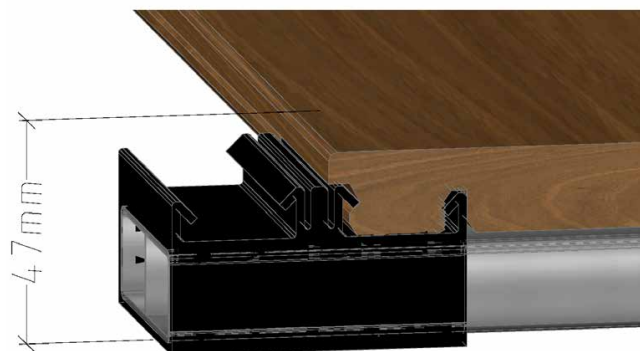

# Before the installation Dos and Donts

Duro is a non porous material so water will stand on the deck for longer than timber decking boards.

-

According to the principles of constructive wood preservation, boards must always be installed with sufficient gradient. (1-2%). Gradient must always be in a longitudinal direction with respect to the boards (direction of the hollow chamber and fluting). The gradient direction must always be away from the building. To ensure compliance, avoid water spots, ponding, dirt deposits and other damage to the building.

-

The subsurface must be structurally sound and frost-protected and have sufficient drainage.

-

For applications requiring approval by the building authorities (e.g. balconies), you need a statically weight-bearing subsurface as support for the floor boards.

-

Permanent ground contact of DURO boards must be avoided!

-

When installing the deck up to a building or parapet wall, always leave at least 2 cm distance to allow sufficient expansion and contraction.

-

Drainage of adequate size is required for the subsurface. Avoid waterlogging and also ensure complete drainage during heavy rainfall

-

Maximum distances for substructures must be adhered to!

-

Observe the minimum distances of the expansion joints to enable the unconstrained expansion of the structure where applicable. Boards are 100% dry after production. Weathering causes them to absorb water and swell. Joints therefore become smaller after a few weeks/months. Thermal expansion must also be taken into account.

-

To guarantee a correct installation and to preserve DURO's surface look, the boards must be stacked out of direct sun contact and in a dry place. When handling the boards, don't slide boards one on top of the other in order to avoid scratches. It is advised to deliver to boards to the site of the installation a day or two before installation to allow them to acclimatise to the conditions. For best results, do not install iDecking boards in temperatures under +10°C.

-

Pre-drill screw connections if any and use a low torque setting.

-

In case of any screw fixation, use only stainless steel screws

-

DURO boards will absorb heat. This heat effect has more of an impact on dark colours than light colours. Take this into account when walking barefoot.

-

**Scratches are an inevitable part of an outdoor surface. Furniture and other items should ALWAYS have a protective applied at the point they touch DURO surface. Tables and chairs, for example, should have rubber discs fitted.**

-

Fade is an unavoidable consequence of outdoor surfaces. To reduce the impact of UV related fade, two coats of DUROSHIELD product must be applied at the time of installation.

-

**TOOLS:** There are no special tools required. To achieve the best results, use saw blades and cutting tools coated with hard metal. If you use a mitre saw, we recommend a saw blade size of 254 - 305 mm with 40 teeth or fewer.

**Refer to the iDecking assembly instructions for all matters concerning modifications during installation as warranty cannot be provided if deviations and resulting deficiencies occur. Warranty is also excluded if you use system boards for any purpose other than for decking boards. You must use the iDecking substructures and assembly parts provided!**

# Installation: EasyClick system

Before Starting you will need to determine the most suitable installation scenario:

- **Scenario A** : Installations on concrete or existing paving using rubber pads or adjustable pedestals bonded or fixed to understructure.
- **Scenario B** : Installations on sensitive roofing membranes where mechanical fixings are not possible using double aluminium rails on pedestals.
- **Scenario C** : Installations over bare earth, using a primary frame with posts concreted into the ground

## SCENARIO A: [EasyClick System installation on small risers](#)

Installations on concrete or existing paving using rubber pads or adjustable pedestals bonded or fixed to understructure.

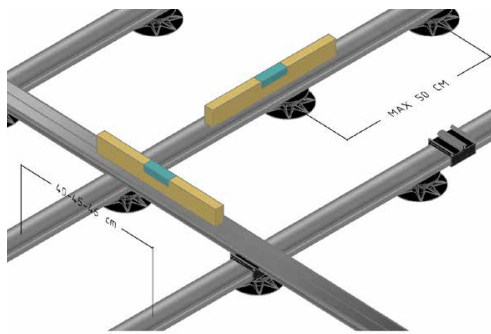

### Leveling with rubber pads

- Position the rubber pads or adjustable pedestals following max of 600 mm interval from one another in the intended direction of the rails.
- Make adjustments to them in order to be all roughly the same level.
- Place the EasyClick rails onto the pedestals.

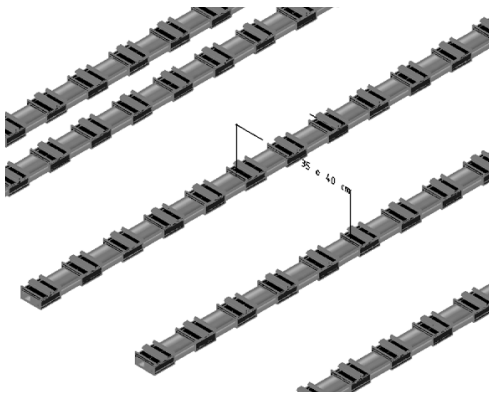

### Placing the EasyClick Understructure

- The interval between the aluminium rails depends on the kind of board chosen for the deck.

- Align the aluminium rails following the suggested interval:

- **Duro**: interval 35cm (public areas) 40cm (private areas)
- **Etherno Bamboo**: interval 46cm

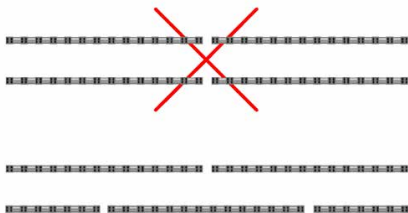

**NO** - Stagger the joints between the rails to ensure a more stable structure.

**YES**



### Fixing the pedestals / supports to the ground

- It is now time to fix the pedestals to the ground.
- In order to fix the supports to the ground, lift the support from the side and inject the necessary amount of glue to fix it on the ground.
- Wait for the glue to stick to avoid support movements.



# Installation: EasyClick system

## ATTENTION:

- in case you need to pull your deck close to a fix point (ie. house, wall) you will have cut half of the first clip as shown in CASE 1 - page 13

## Laying the first board

- Lay the board over the aligned rail.
  - Click it by pressing down with your foot, first on one side (1) then the other side (2) onto the clips below.
  - Repeat the operation over each intersection between board and rail.
  - When the height doesn't allow the use of your foot, use a rubber mallet to click the boards in place.
  - It is now time to fix the rails to the pedestals. Slightly lift the rails and apply a sufficient amount of glue to the head of the pedestal before replacing the rail in the centre of the pedestal head.
  - Don't wait for the glue to completely dry. This allows a certain degree of movement needed to square the whole structure.
  - Click in every 4th or 5th board in order to square the whole deck structure. This allows alignment of the rails that will then be ready to be fixed to the ground.
- IMPORTANT: the position of each board has to be judged with care, paying close attention on alternating the board edges meeting point.
- Remember to fit iJack expansion control bracket to each board if present.
  - When installing large decks, we suggest installing smaller areas at a time and connecting the separate areas together.

## For best results use mechanical fixings to screw the rails to the ground

- To fix the understructure to the ground, Drill and fix the aluminium rails to the ground.

## Completing the deck

- Complete the deck by clicking the rest of the boards.

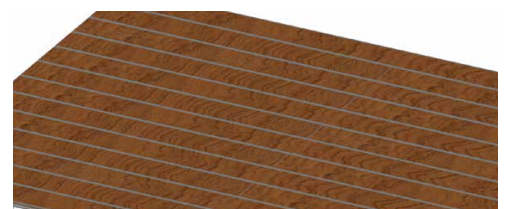
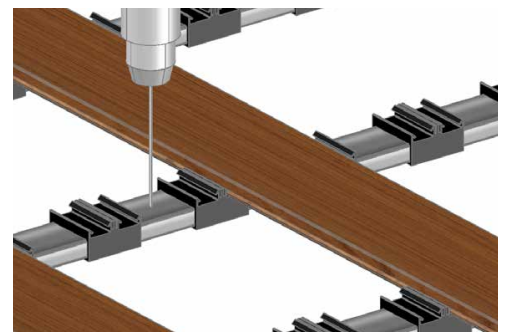
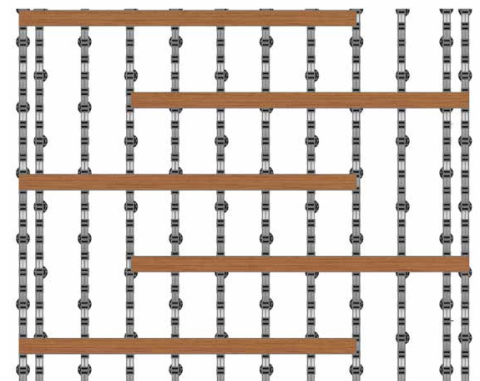
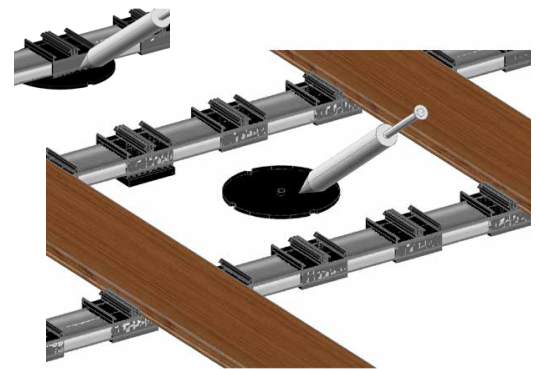
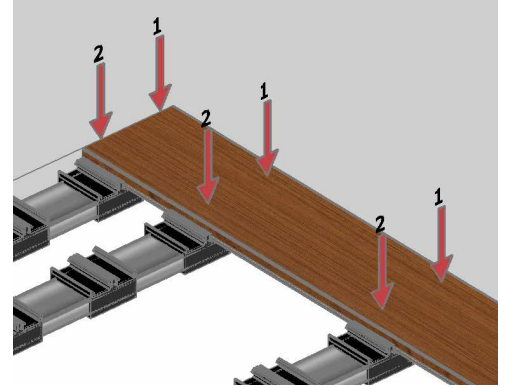

# Installation: EasyClick system

## Scenario B: [EasyClick system installation on Jack Supports \(adjustable risers\)](#)

installations on sensitive roofing membranes where fixing down of iDecking is not possible, an additional “blank rail” is required for this method of installation



- Position the rubber pads or adjustable pedestals following max of 600 mm distance from one another in the intended direction of the deck boards.
- Adjust the height of the pedestals to create a level under surface.

- Place the “blank rails” at intervals of 600mm for domestic decks and 500mm for public areas allowing for a 1-2% fall.

### Placing the iDecking Rails

- Cross the iDecking “A” or “B” Rails over the “blank rail” placing them at the advised intervals (Duro Excellence at 400mm for domestic use or 350mm for public use • EthernO Bamboo at 450mm intervals)

### Laying the first board

- Lay the board over the aligned rail.
- Click it by pressing down with your foot, first on one side (1) then the other side (2) onto the clips below.
- Repeat the operation over each intersection between board and rail.
- When the height doesn't allow the use of your foot, use a rubber mallet to click the boards in place.

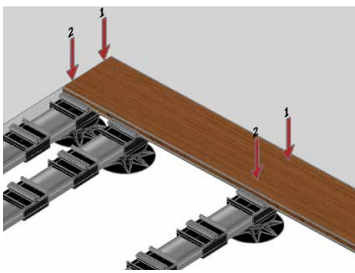

#### **ATTENTION:**

- in case you need to pull your deck close to a fix point (ie. house, wall) you will have cut half of the first clip as shown in CASE 1 - page 13

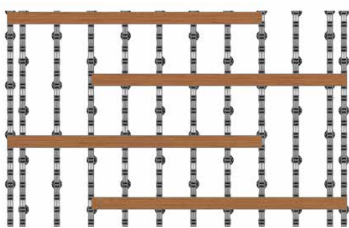

### Installing the remaining boards

- Click in every 4th or 5th board in order to square the whole deck structure. This allows alignment of the rails that will be then ready to be fixed to the ground. **IMPORTANT:** the position of each board should be judged with care, paying close attention on alternating the board edges meeting point.
- Remember to fit iJack expansion control bracket to each board if available.
- At this point you will need to fix the two rails together with self drilling screws on the rails underneath.
- When installing large decks, we suggest installing smaller areas at a time and connecting the separate areas together.

### Completing the deck

- Complete the Deck by clicking the rest of the boards.

### Weight plates

- When installation is on inverted roofs (insulation above membrane) weight plates will be needed. They are hung between the rails to add ballast to the deck area.

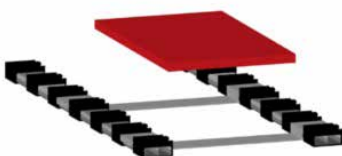

# Installation: EasyClick system



## SCENARIO C : Installations over bare earth, use a primary frame with posts concreted into the ground

- Build a bearer framework in the chosen area with posts concreted into the ground.
- For best results use Galvanised steel frame with bearers positioned at intervals of 600mm for domestic applications and 500mm for public areas

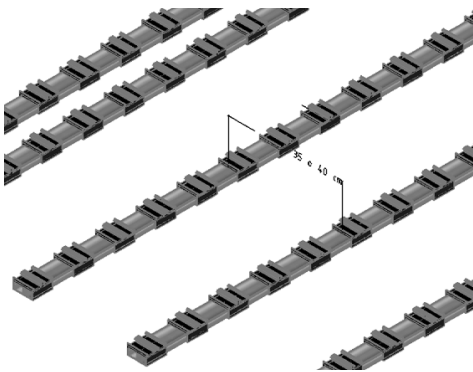

## Placing the iDecking Rails

- Cross the iDecking Rails over the bearer framework placing them at the advised intervals (Duro Excellence 400mm for domestic use or 350mm for public use • EthernO Bamboo: interval 450mm)

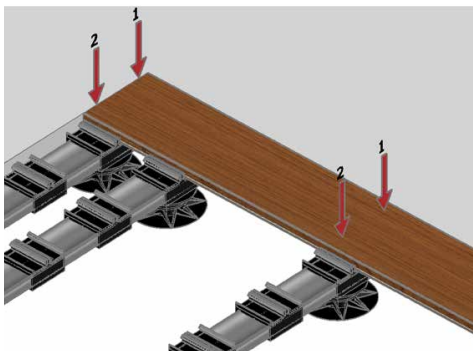

## Laying the first board

- Lay the board over the aligned rail.
- Click it by pressing down with your foot, first on one side (1) then the other side (2) onto the clips below.
- Repeat the operation over each intersection between board and rail.
- When the height doesn't allow the use of your foot, use a rubber mallet to click the boards in place.

### ATTENTION:

- in case you need to pull your deck close to a fix point (ie. house, wall) you will have cut half of the first clip as shown in CASE 1 - page 13

- Repeat the operation over each intersection between board and understructure.

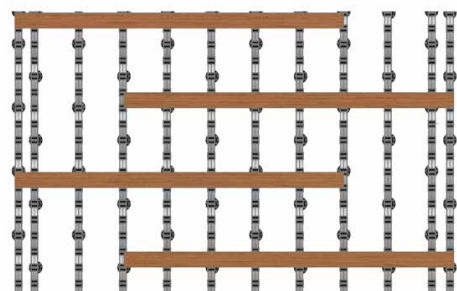

## Installing the remaining boards

- Click in every 4th or 5th board in order to square the whole deck structure. This allows alignment of the rails that will be then ready to be fixed to the ground. IMPORTANT: the position of each board should be judged with care, paying close attention on alternating the board edges meeting point.
- Remember to fit iJack expansion control bracket to each board if available.
- At this point you will need to fix the two rails together with self drilling screws on the rails underneath.
- When installing large decks, we suggest installing smaller areas at a time and connecting the separate areas together.

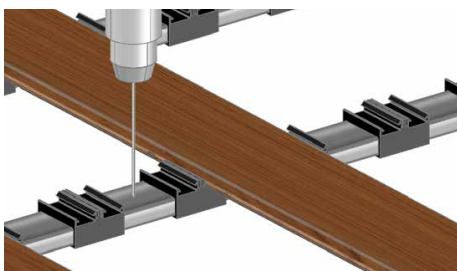

## Completing the deck

- Complete the Deck by clicking the rest of the boards.

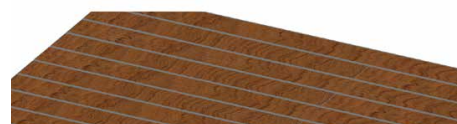



# Installation: EasyClick system

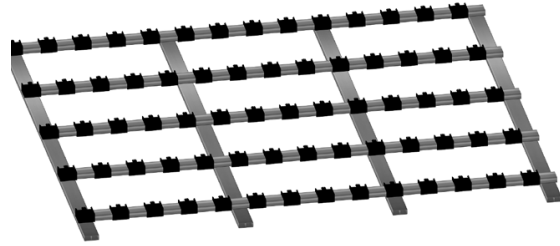
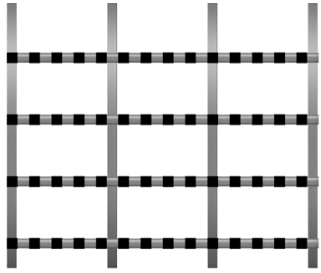

## Installation with a Primary Understructure

necessary when it's impossible to fix the rails on the ground

- Place the Primary Aluminum Rails with an interval range of 65/70 cm one from the other. The section of the Aluminum rails used for Primary Understructure is: 30 x 50 x 3 mm. – 1200gr/m

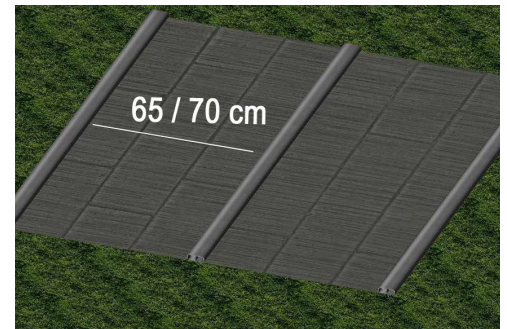

## Placing the iDecking Rails

- Cross the iDecking Rails over the Primary understructure placing them at the advised intervals as shown in CASE A & B (**Duro:** interval 35cm public use / 40cm private use • **Etherno Bamboo:** interval 46cm) and fix them with self drilling screws on the rails underneath.

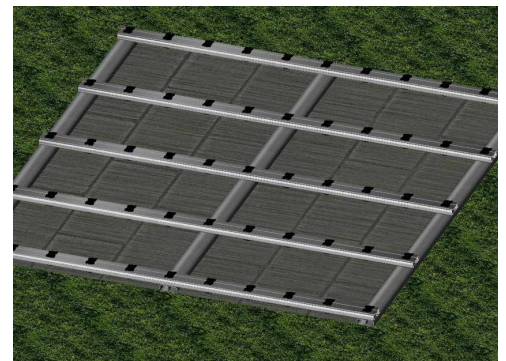

## Completing the deck

- Complete the Deck by following the guidelines of the chosen iDecking System: EasyClick or EasyChange and place the rest of the boards



# Modules: EasyClick system

## EasyClick MODULES deck building

The Clip B lets you pre-build the modules of your future deck. This solution is even quicker in installation time and it is highly suggested in case of big areas to cover or temporary decks that will have to be removed and re-installed.

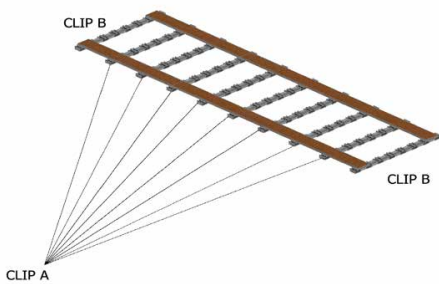

### Create the module understructure

- Place the aluminum rails at the right interval:  
**Internals** clip A rails,  
**Externals** clip B rails



### Complete the module

- Complete the Module assembling by clicking the rest of the boards.  
**SUGGESTION: create the module with a maximum of 7 boards and with understructures cut half in order to handle them easier.**

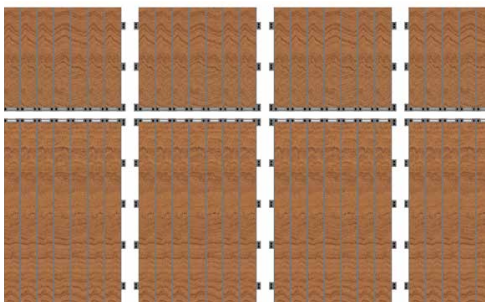

### Creating the deck

- After preparing the Modules and having verified the ground level, place the modules over the desired area. Distance them in order to let the connecting board be clicked correctly.

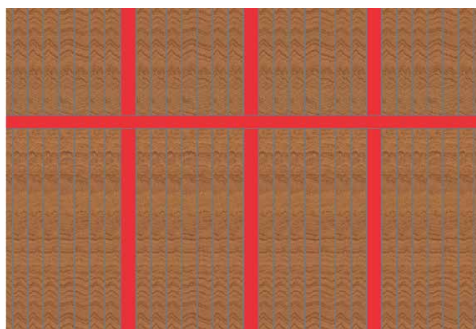

### Completing the deck

- The Clips B present on the short external sides of the single modules will let you connect the modules even in longitudinal sense.
- Insert the connecting boards (highlighted in red) both in latitudinal and longitudinal sense.

# frames and finishes **EasyClick system**

## Installation of EasyClick STEP PROFILE

EasyClick system allows a clickable framing/nosing profile called Step Profile, to be easily and quickly installed.



### **Installation parallel to boards direction**

- Click the Step Profile onto the remaining half clip at the end of each "A" rail.

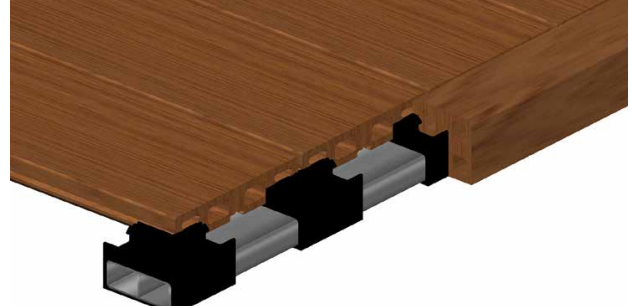

### **Installation perpendicular to boards direction**

- Use the Clip B understructure at the end
- Click the Step Profile in the remaining half clip at the end of each understructure

## Creating inspectable manholes

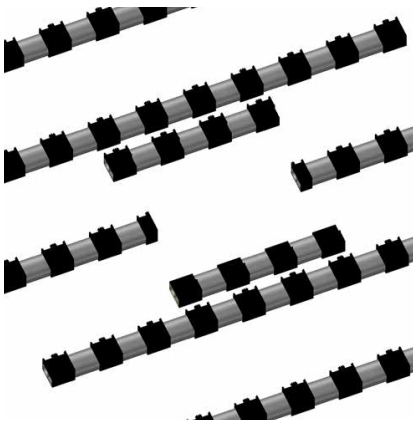

### **Placing the alu rails**

- Cut small sections of "A" rail to the size of the manhole.
- Insert two pieces of aluminum understructure as reinforcement of the manhole.

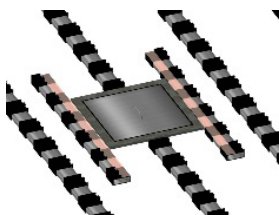

- Remove a part of the clips to create the manhole support.

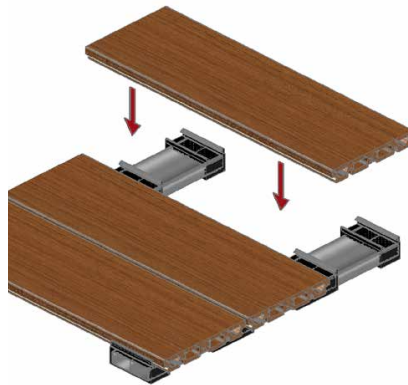

### **Creating the manhole**

- Cut boards to the length of the manhole.
- Click boards into the clips on the "A" rails to create a small section of decking.
- Ensure that the rails are set back from the end of the boards.

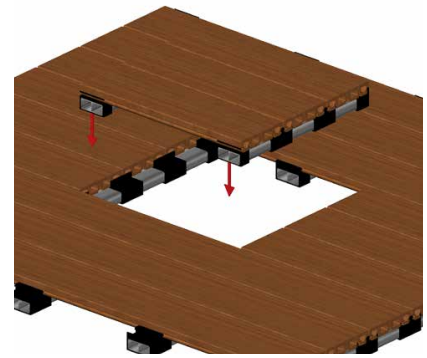

### **Completing the job**

- Place the manhole over the opening: the projections of board then lie on the surrounding understructure profiles.

# frames and finishings **EasyClick system**

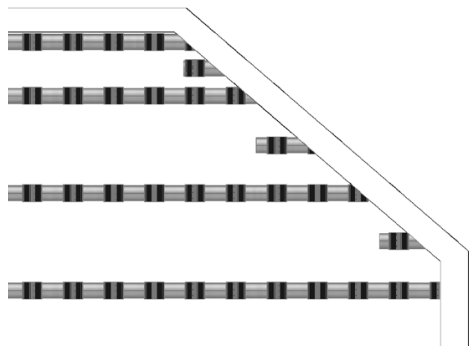

## Diagonal cuts

- Cut the final part of the understructures following the desired angle.
- Add portions of understructure "A" among the principal ones, to ensure correct support for the boards to click to.

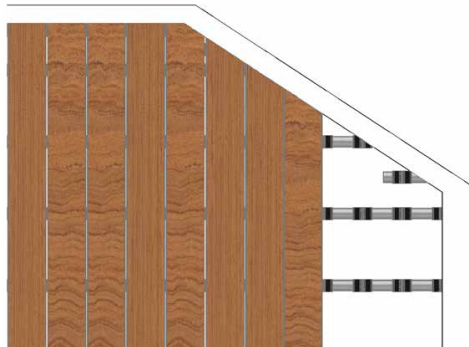

## **Complete the deck**

- Cut the boards according to the desired size and complete the deck.
- SUGGESTION:** if a board ends up to be over an understructure portion where there is no clip, we suggest placing a packer on the rail and gluing the boards down.

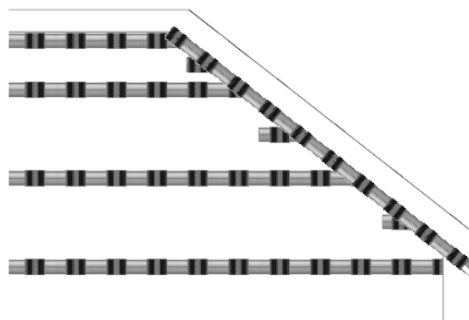

- If a step profile is required on the diagonal, place a "B" rail on the diagonal with the parallel clip pins removed.
- The Step profile clips to the outside of the "B" rail.

## Rounded cuts



- Create the deck normally and let the boards protrude over the area that will have to be round cut.
- Perform the cut with the right tools
- Make sure the understructure has a support clickable point at the end of each board.

## **Framing profile DURO 10x95mm**

- Once cut, it is possible to install the special 10x95mm framing profile.
- Heat the profile with a hot air gun and bend the framing profile around the shape of the curve.
- Fix it with screws while bending it.
- Once the profile cools down, it will maintain the given bent shape.





# frames and finishings **EasyClick system**

## Rounded cuts - placing the understructure

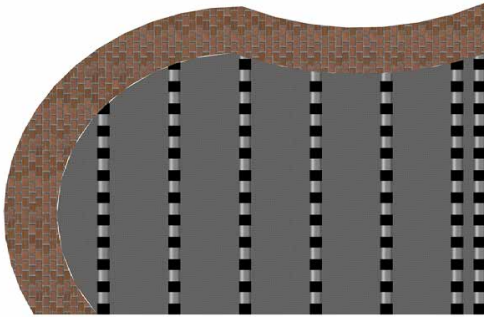

- Cut the final part of the understructures following the desired angle.

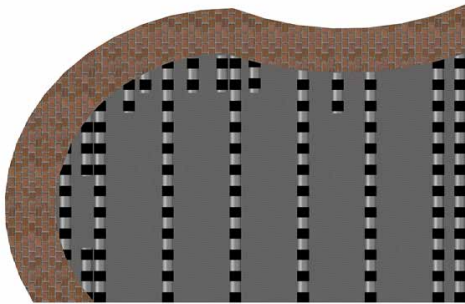

- Add portions of understructure among the principal ones, otherwise the boards would not be supported in the final part

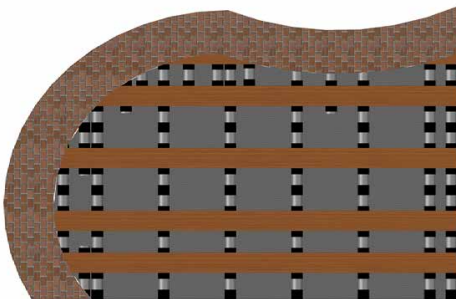

- Cut the boards according to the desired size and complete the deck.

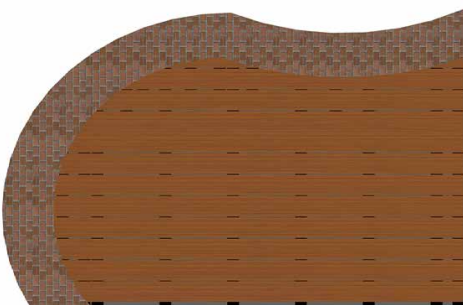

### **Complete the deck**

**SUGGESTION:** if a board ends up to be over an understructure portion where there is no clip, we suggest a glue point to fix it.

# frames and finishes **EasyClick system**

## How to pull the boards close to a wall

### **CASE 1: cutting the clip**

- Cut the final part of the clip as shown in the picture.

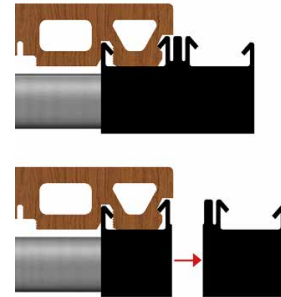

### **CASE 2: cutting the board**

- Cut the board according to the needed size

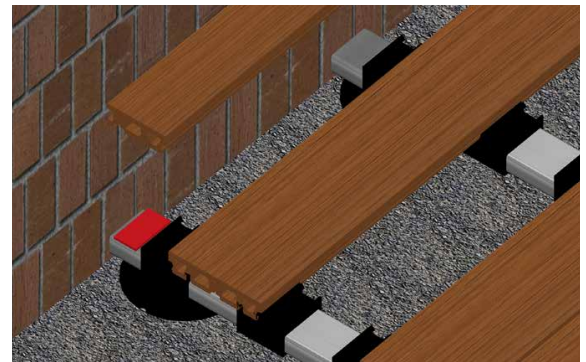

- put a rubber riser as shown (in red) in the picture to ensure the board is properly supported underneath.

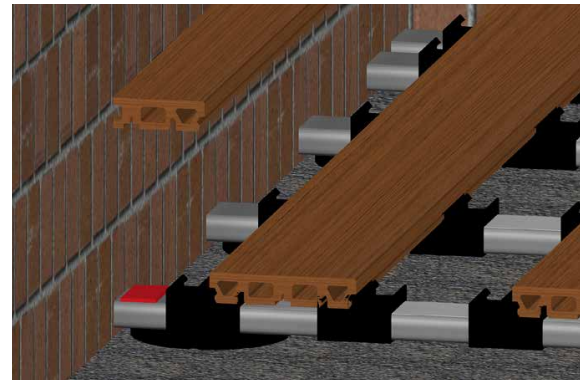

- Click the board and for best results screw the outer edge of the board down in order to secure it firmly.

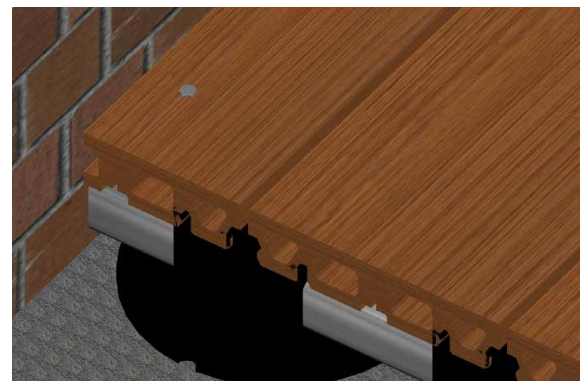

# Optionals EasyClick

## iJack: expansion control bracket

iJack was developed to overcome one of the issues of composite decking expansion & contraction by locking the ends of each board together to the gap stays constant.

- Duro Excellence boards are already drilled on the underside in preparation of taking the iJack

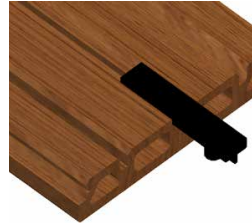

- Turn the Duro board and click the iJack into the pre-drilled hole, pay attention to leave the flat sides of the iJack out.

- Turn the board and click it to the understructure. Go on with the rest of the boards if necessary.

- In case a board is cut more than one time, it's possible to re-create the iJack hole drilling the board in the length direction at 17mm from the edge with a 10mm drill bit.

- **ATTENTION:** Boards connect both with or without iJack can be installed for a maximum length of 12 meters in the same direction. Beyond this size we advise to break the design of the deck using the CLIP B understructure.



## Counterweight plates

Useful accessory to use when it's not possible to drill the soil. Counterweight plates are 50x30x2cm and 24kg each.

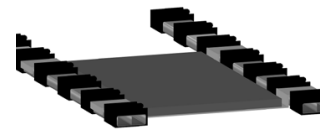
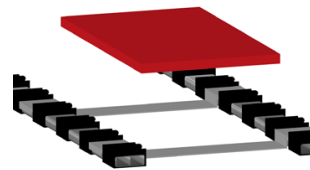

We suggest to place the plates around the perimeter of the deck at a spacing of 1 metre one from each other. In the case of much larger areas we suggest to place the plates in the pattern illustrated to the right.

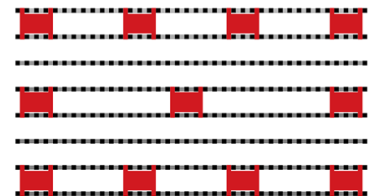

## ClickOUT

ClickOut is the tool to "unclick" the DURO / Bamboo boards from the system

- **ATTENTION:** EasyClick system is the only in the world to block each board on 4 different points. The board will definitely make a strong opposition in the process of taking it out. We suggest to be careful during the operation in order not to encounter brakages. It is recommended to perform this activity during the warmest hours of the day (in order to have both clips and boards naturally softened).



# Maintenance products for iDecking



## DURO SHIELD

- Duro Shield is a water-based compound formulated with high penetrating nanotech particles for the treatment of DURO composite materials.
- Duro Shield makes the treated surfaces water/oil-repellent, avoiding the formation of unaesthetic and persistent stains due to the absorption of oil substances and dirt. It gives a slight toning effect, excellent resistance



## DURO DROP

- Duro Drop is a water-based application that gives extra protection to Duro Excellence and is used in conjunction with Duro Cleaner.
- Duro Drop makes the treated surfaces water-oil-repellent, avoiding the formation of unaesthetic and persistent stains due to the absorption of oil substances and dirt.
- It gives a slight toning effect, excellent resistance and colour stability.



## DURO CLEANER

- Duro Cleaner is an Intensive anti-bacterial cleaner for Duro Excellence with a special plant-based formula for intensive cleaning.
- Ideal for regular cleaning maintenance.
- Contains less than 5% of surface-active agents.
- 90% biodegradable.



## DURO INTENSIVE CLEANER SPRAY

- DURO Intensive Cleaner is a spray cleaner suitable for the removal of all the kind of deep spots on treated and not-treated DURO excellence products.
- Intensive Cleaner acts with strong efficacy, solubilizing even the tough dirt, where the regular detergent is not effective.
- It does not leave halos and it does not discolour the material.



# Maintenance requirements for iDecking

## Before Use



Apply 2 coats of **DURO SHIELD** preferably before or during installation.

If done after the installation, make sure to deep clean it with **DURO CLEANER** and then apply the coats of **DURO SHIELD**.

*This treatment makes the deck easier to clean and slows down the rate of fade.*



## Regular maintenance

### Clean the Deck:

Use **DURO CLEANER** to wash the dirt from the deck. The deck can also be cleaned with a high pressure hose. Dilute DURO Cleaner in water (3 capfuls in 1 litre of water). Wash the floor with a well wrung out cloth. Rinse free. Recommended frequency: 15 days.



### Protector:

Once the deck is clean, use **DURO DROP** applying it with a rag or sponge and allow to dry. Using **DURO DROP** protects the deck from stains and everyday grime. This can be re-applied regularly. As it is a more fluid material than **DURO SHIELD**, it is applied much easier and delivers a higher yield. For **DURO DROP** to work correctly, the boards have to have been protected with **DURO SHIELD**.



### Oil/Fat Spots:

For persistent fat/oil spots apply the **DURO INTENSIVE CLEANER SPRAY**.

Shake well **DURO Intensive Cleaner** before the use. Spray it directly on the spots that have to be removed, keeping a 25 cm distance.

Let the product act for at least 2-3 minutes than brush and rinse with water. In case of tough dirt, re-apply **DURO INTENSIVE CLEANER** following the same procedure. The subsequent protective treatment can be performed with **DURO DROP**.

# EasyClick system

## Deckbuilder's zone

Professional Deck builders will be extremely happy to know that iDecking EasyClick system won't force them on their knees all day long and will also drastically reduce installation time!

Say good bye to wasting your time aligning each decking board since our EasyClick system automatically aligns it for you! EasyClick understructure "rails" are placed every 40 cm, locking each decking board on four different points increasing the strength of the entire floor/wall structure.

Special EasyClick clips are also available to serve any decking design.



**iDeckKing**  
R E V O L U T I O N

[www.idecksystems.com](http://www.idecksystems.com)