

iFly Clip

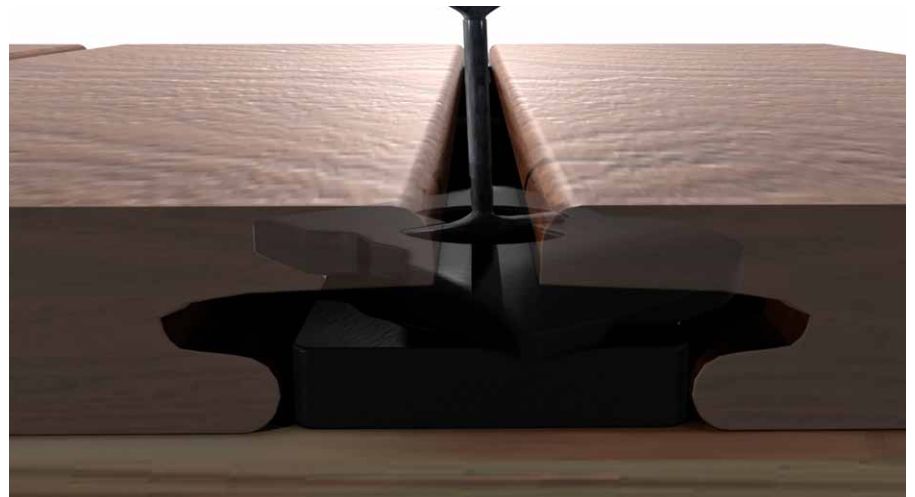

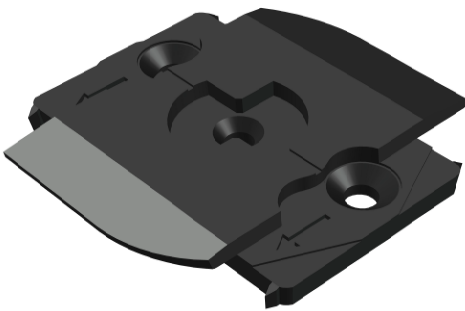
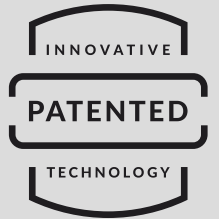

Hard Rock
HOTEL

Hard Rock
HOTEL

index

READ CAREFULLY BEFORE STARTING THE INSTALLATION

Components	page 4-6
Tools you might need	page 7
Before the installation - dos and donts	page 8
Preliminary evaluations	page 9
Substructure	page 10
Fixing the substructures	page 11
Substructures on leveling discs	page 12
Primary substructure	page 13
Primary substructure with leveling discs	page 14
Adjustable pedals	page 15
Boards head junction	page 16
iJack	page 17
Start/End Clip	page 18
Key	page 19
Framing profiles	page 20
Duro Maintenance	page 21

components

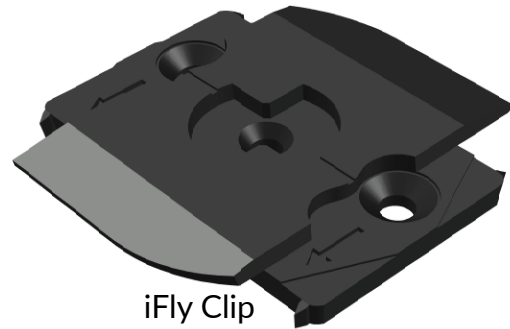

iFly Clip

IDECKING REVOLUTION BOARDS - DETAILS

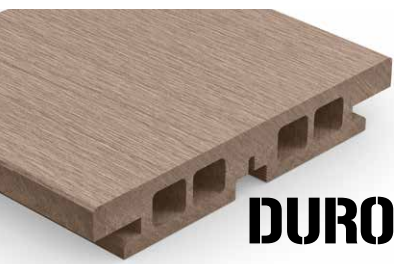

DURO

Duro boards are made from circa 50% RICE HUSK and 50% virgin PVC and Minerals in order to deliver a product with as natural a look and feel as possible. As it happens for wood, Duro composite material can encounter a slight chromatic change due to UV rays. After only a few months the boards will stop further chromatic change and become colour fast. For covered or partially shaded areas this process will take longer. Using our specific products (Duro Shield and Duro Drop) it is possible to protect Duro's look from stains and slow down the rate of fade. Furniture like flower boxes can also cause colour change to the deck area so it is advised to change the position of this furniture during the first 3-6 months in order to maximum colour compensation.



ETHERNO

Minimal changes in colour and tone underline the natural aspect of EthernO Bamboo, just like in any other noble wood (ie. IPE / TEAK). Colour variations, like profile and surface alterations, are normal in the natural behaviour of any wood and don't represent vices or defects in the product so are not cause of a claim. In order to get uniformity over the deck area, it is advised to mix up the boards before installation.

Just turn the key and replace any board!

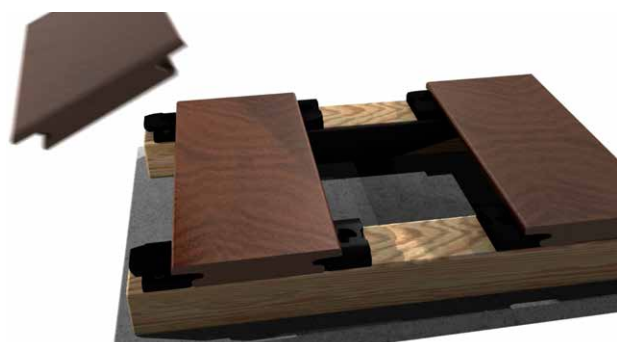
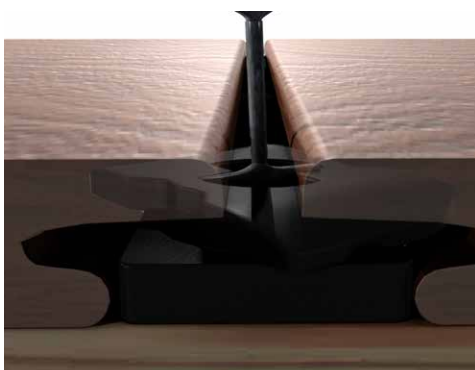

Technical infos on components

Kind of substructures where it's possible to install the iFly Clip

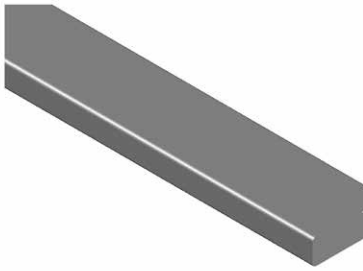

Aluminum profile

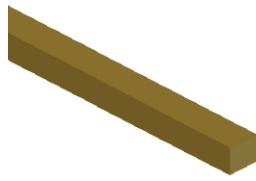

Wooden profile

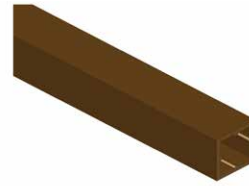

Composite profile

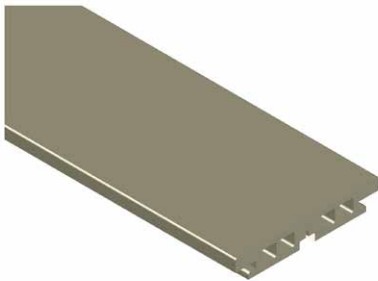

EasyChange board
Duro/DURO Excellence - flat/antiSlip
140 x 23.5 x 2800 mm

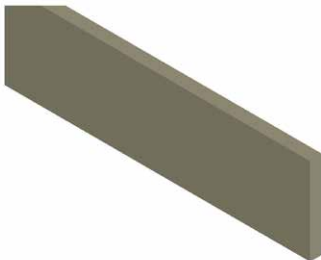

Framing profile
Duro/DURO Excellence
25 x 70 x 2200 mm

Framing profile
Duro/DURO Excellence
10 x 95 x 2200 mm

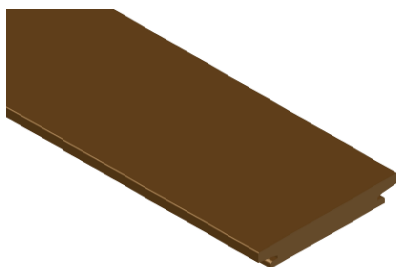

EasyChange board
ETHERNO BAMBOO flat/antiSlip
140 x 20 x 1870 mm

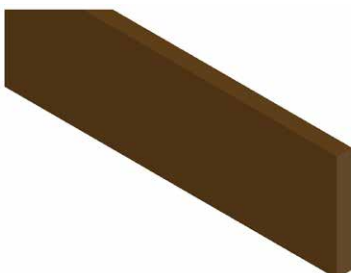

Framing profile
Etherno Bamboo
140 x 20 x 1870 mm

Technical infos on components

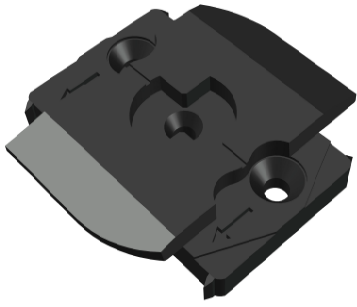

iFly Clip



Start/End Clip

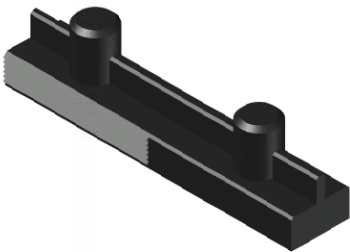

iJack head connector (only for DURO/DURO EXCELLENCE)



EasyChange Key (locks/unlocks the board)



Leveling disc from 3mm to 8mm



Adjustable pedestals 10 - 1020mm

Tools you might need



Drill / Cordless Drill



Silicone and glue outdoor resistant



Bubble level



Screws diameter 3,5mm (stainless steel)



and/or plugs to fix the aluminum rails to the ground



Jigsaw to cut irregular perimeters



Saw to cut aluminum and boards to the desired size

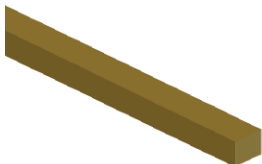

Use regular screws to fix the iFly clip on wooden profiles.

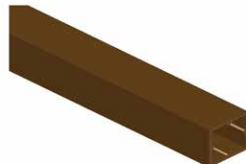

Use regular screws to fix the iFly clip on composites profiles.

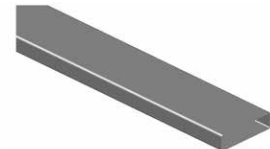

Use self drilling screws to fix the iFly clip on aluminum profiles.

Before the installation Dos and Donts

Duro is a non porous material so water will stand on the deck for longer than timber decking boards.

- According to the principles of constructive wood preservation, boards must always be installed with sufficient gradient. (1-2%). Gradient must always be in a longitudinal direction with respect to the boards (direction of the hollow chamber and fluting). The gradient direction must always be away from the building. To ensure compliance, avoid water spots, ponding, dirt deposits and other damage to the building.

- The subsurface must be structurally sound and frost-protected and have sufficient drainage.

- For applications requiring approval by the building authorities (e.g. balconies), you need a statically weight-bearing subsurface as support for the floor boards.

- Permanent ground contact of DURO boards must be avoided!

- When installing the deck up to a building or parapet wall, always leave at least 2 cm distance to allow sufficient expansion and contraction.

- Drainage of adequate size is required for the subsurface. Avoid waterlogging and also ensure complete drainage during heavy rainfall

- Maximum distances for substructures must be adhered to!

- Observe the minimum distances of the expansion joints to enable the unconstrained expansion of the structure where applicable. Boards are 100% dry after production. Weathering causes them to absorb water and swell. Joints therefore become smaller after a few weeks/months. Thermal expansion must also be taken into account.

- To guarantee a correct installation and to preserve DURO's surface look, the boards must be stacked out of direct sun contact and in a dry place. When handling the boards, don't slide boards one on top of the other in order to avoid scratches. It is advised to deliver to boards to the site of the installation a day or two before installation to allow them to acclimatise to the conditions. For best results, do not install iDecking boards in temperatures under +10°C.

- Pre-drill screw connections if any and use a low torque setting.

- In case of any screw fixation, use only stainless steel screws

- DURO boards will absorb heat. This heat effect has more of an impact on dark colours than light colours. Take this into account when walking barefoot.

- **Scratches are an inevitable part of an outdoor surface. Furniture and other items should ALWAYS have a protective applied at the point they touch DURO surface. Tables and chairs, for example, should have rubber discs fitted.**

- Fade is an unavoidable consequence of outdoor surfaces. To reduce the impact of UV related fade, two coats of DUROSHIELD product must be applied at the time of installation.

- **TOOLS:** There are no special tools required. To achieve the best results, use saw blades and cutting tools coated with hard metal. If you use a mitre saw, we recommend a saw blade size of 254 - 305 mm with 40 teeth or fewer.

Refer to the iDecking assembly instructions for all matters concerning modifications during installation as warranty cannot be provided if deviations and resulting deficiencies occur. Warranty is also excluded if you use system boards for any purpose other than for decking boards. You must use the iDecking substructures and assembly parts provided!

Preliminary evaluations

First and most important is to choose what kind of installation to perform according to the kind of ground, slope and fixing possibilities it allows. Based on these factors, choose the adequate way to install as follows:

Case A - Substructure page 11

To be used when you can fix your substructure to the ground. The final height of the floor depends on the section of the profile you chose for the installation.

Case B - Substructure with leveling discs page 12

To be used when you can fix your substructure to the ground. The final height of the floor depends on the section of the profile you chose for the installation, with necessity to rise/adjust the levels till 8mm using leveling discs.

Case C - Primary Substructure page 13

To be used when you cannot fix the substructure directly on the ground. In this case you can build a primary substructure. The final height of the floor depends on the section of the profiles you chose for the installation.

Case D - Primary substructure with Leveling Discs page 14

To be used when you cannot fix the substructure directly on the ground. In this case you can build a primary substructure. The final height of the floor depends on the section of the profiles you chose for the installation. With necessity to rise/adjust the levels till 8mm using leveling discs.

Case E - Adjustable Pedestals page 15

Use the adjustable pedestals when you don't succeed in reaching the desired height level with just the substructures.

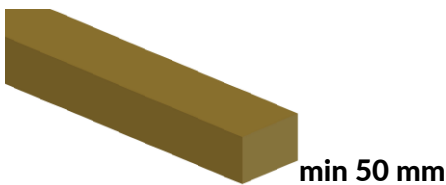

Minimum profile width to install the iFly Clip correctly is 5cm.

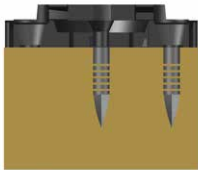

The length of the screw must be chosen according to the section of the used profile.



For a correct installation of the start/end clip, we recommend to pre-drill the holes before putting the screw.

In certain cases you might need to pre-drill even the holes in the iFly Clip. This necessity depends on the chosen material for the substructure.

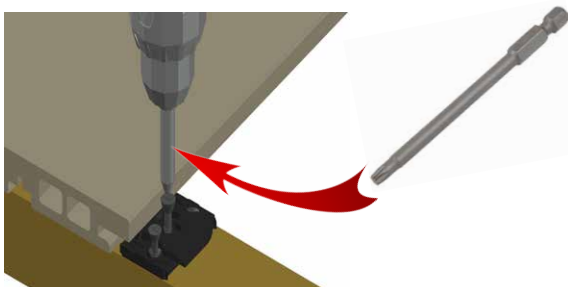
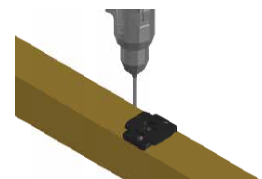

We always suggest to fix the clip using two screws, the middle one is compulsory, the second can be both left or right side.

Substructure -for all the cases-

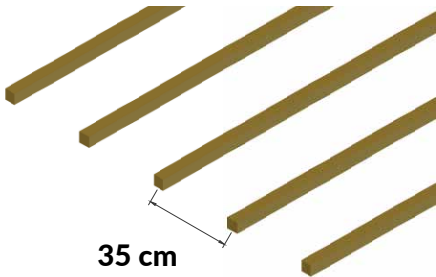

Max suggested interval between rails: 35cm

Calculate the interval according to the board length

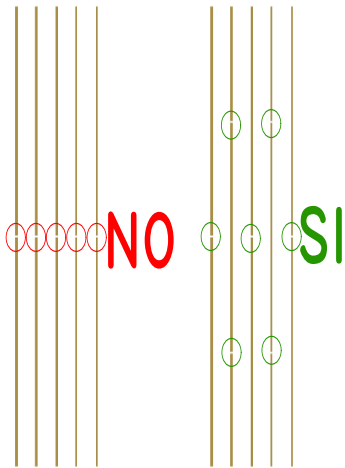

Rails installation must always be staggered in order to avoid joints meet over the same line (creating a weak point)

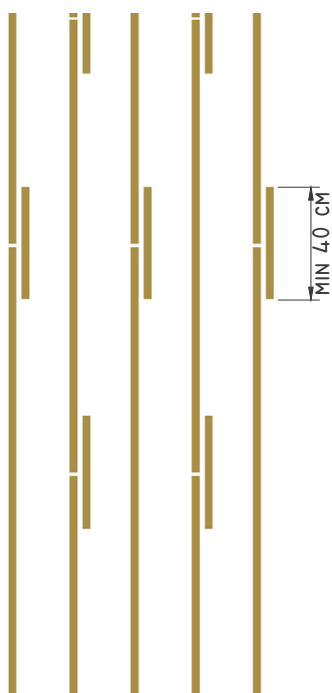

*Professional
advice*



Reinforcing the rails by adding some extra rail pieces (40cm circa) in proximity of the joints can be helpful to increase the strenght.

It could be particularly useful in case there is no possibility to stagger the rails.

BASIC CONCEPTS

Correct installation of iFly clip:

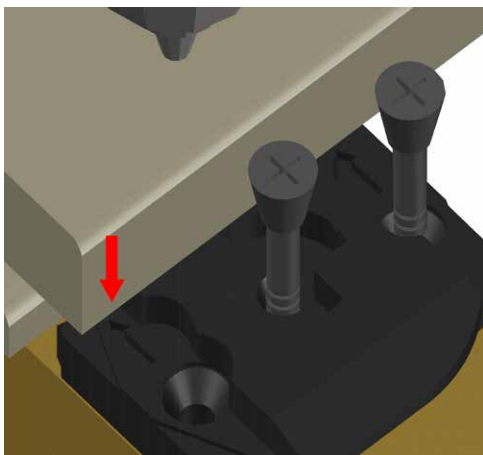
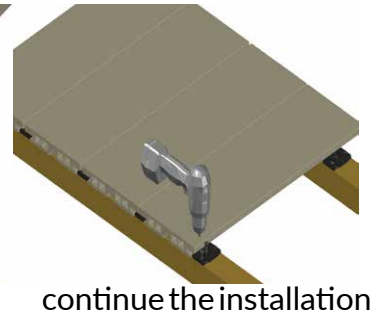
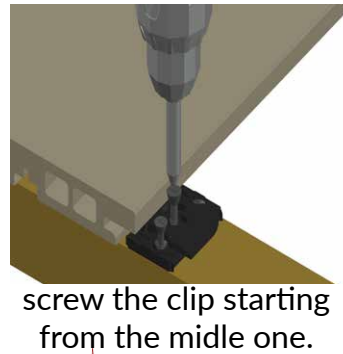
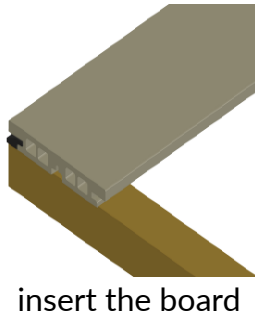
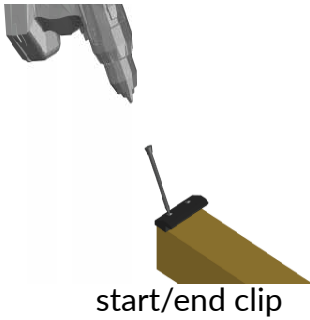

ATTENTION: make sure to orientate the clip with the 2 arrows going under the board.

Fixing the Substructure - CASE A -

Substructure must always be fixed to the existing ground.

If this is not possible, please adopt the primary understructure solution as shown on this guide at page 14 - **Primary substructure with Leveling Discs**



We recommend to fix each substructure every 65cm.

Fixing Screws/Plugs must be chosen according to the kind of basement/ground you have.

Substructure with Leveling Discs

- CASE B -



Leveling discs are made of rubber and they are used to rise the points where there's a little difference between the bottom of the rail and the ground.

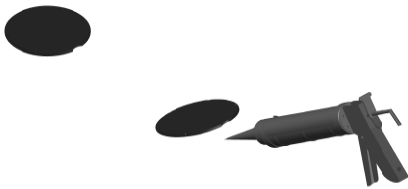

Fix the discs to the ground with a glue for outdoor use. In the case it's not possible this fixing.

If this is not possible, then you can use a primary substructure in aluminum. See the installation guide chapter at page 14 - **Substructure on Primary Substructure with leveling Discs.**

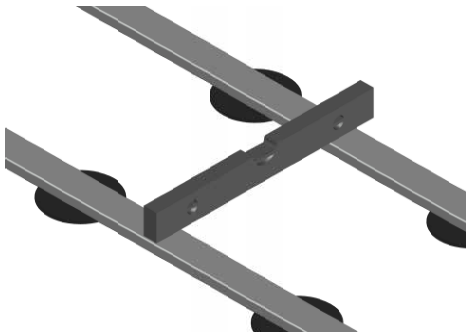

Proceed with the substructure placement paying attention to well level it. Insert the discs where necessary.

Fix the substructure by using the needed screws.

The kind of screw/plug to fix the rail must be chosen according to the kind of ground.

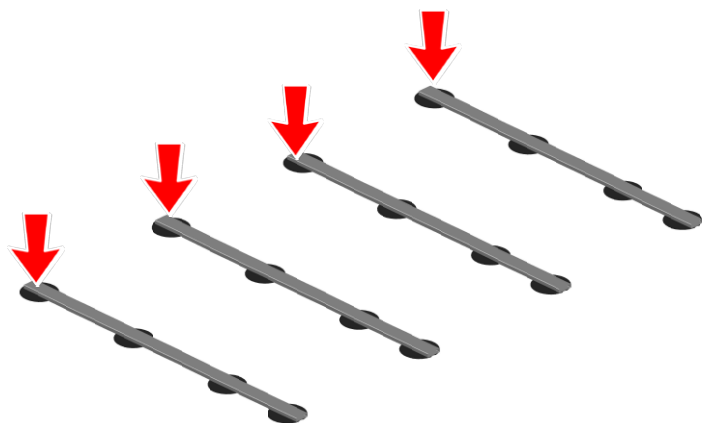

Primary Substructure

- CASE C -

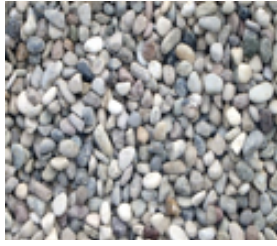

Primary substructure can be made with the PRSOT1200 aluminum profile and it's needed to create a primary base where to fix the EasyChange rails (in all the cases where fixing the EasyChange rails directly on the ground is not possible).

The most frequent cases are:



- Installation over adjustable pedestals
- Installation over sand, grass, gravel and similars.
- Installation over balconies and terraces with waterproof sheath

In all these cases, primary substructure must be necessarily used to guarantee the stability of the deck

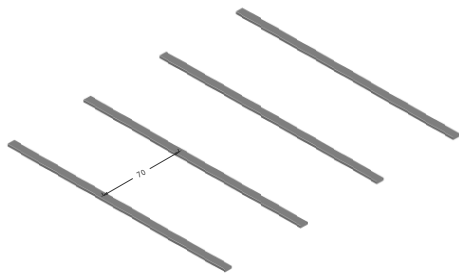

Max interval allowed: 70 cm

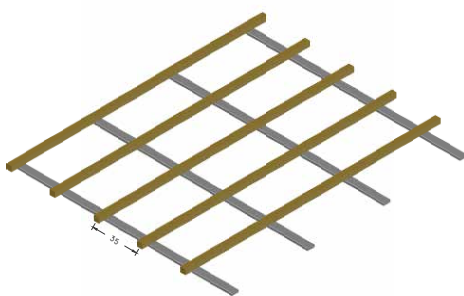

Proceed with the substructures installation by fixing them at every intersection between the Rails and the Primary Substructure

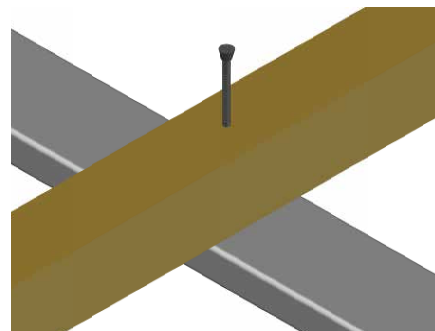

Leveling Discs with Primary Substructure

- CASO D -



Leveling discs are made of rubber and they are used to rise the points where there's a little difference between the bottom of the substructures and the ground.

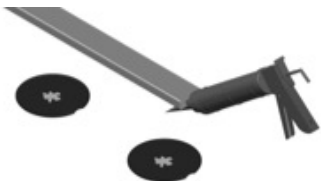

If possible, fix the discs on the ground by using an outdoor weatherproof glue.

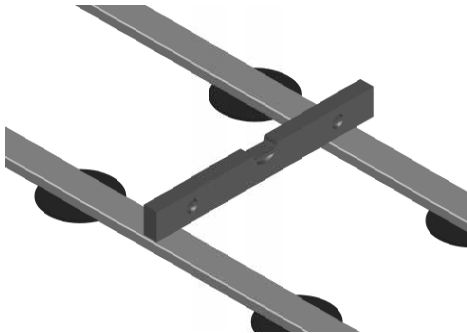
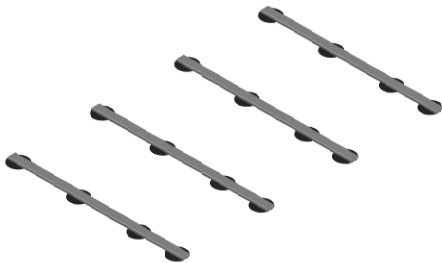

Proceed with the primary substructure profiles placement paying attention to level them well. Insert the discs where necessary.

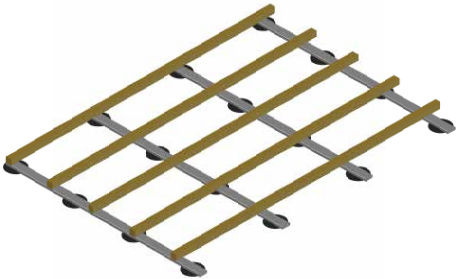

Proceed with the substructures installation by fixing them at every intersection between them and the Primary Substructure

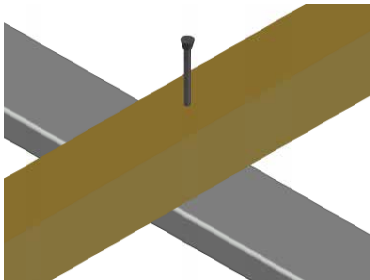

Adjustable Pedestals

- CASE E -



Adjustable pedestals are made of plastic. Very useful when there's the necessity to fix uneven ground levels. These can be regulated from a minimum of 10mm till reaching 1020mm. adapting to any kind of needing.

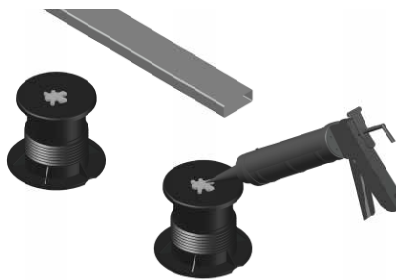

If possible, fix the pedetals on the ground by using an outdoor weatherproof glue.

To fix the pedestals to the primary substructure use screws or glue.



Proceed with the primary substructure profiles placement. Level the substructure by regulating the pedestals height.

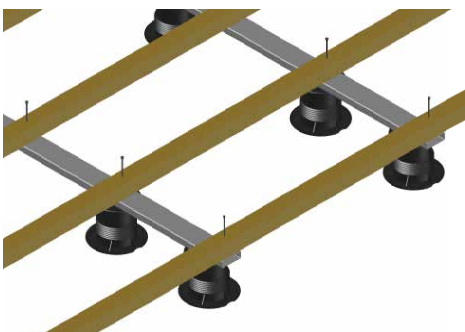

Proceed with the substructures installation by fixing them at every intersection between them and the Primary Substructure

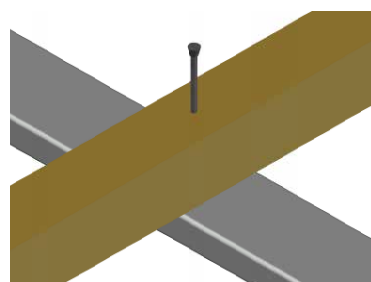

Boards head junction



Once establishing the deck desing, you'll know all the points where the boards join their heads; in correspondence of these points, it's necessary to double the EasyChange rails to give better stability to the boards heads.

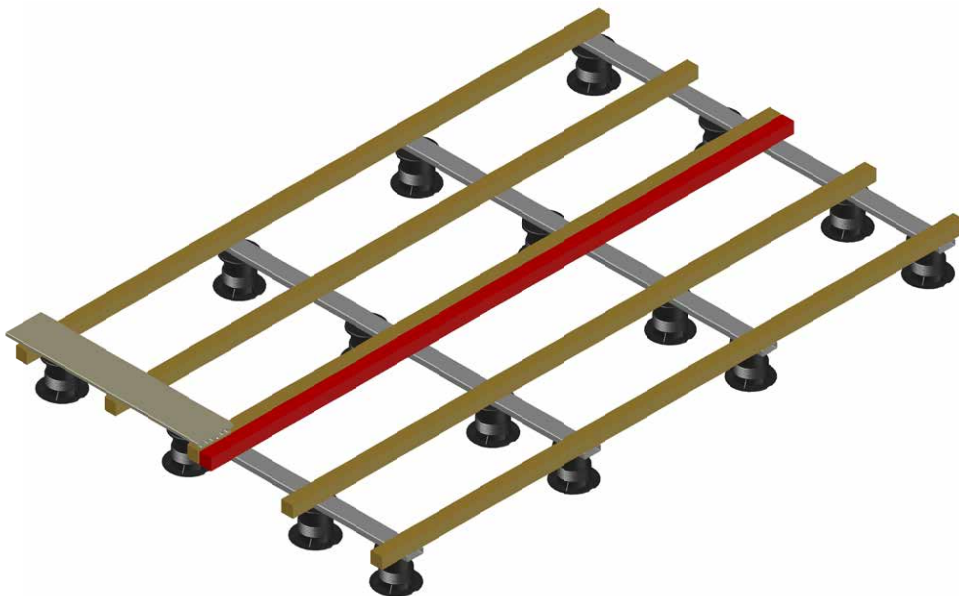
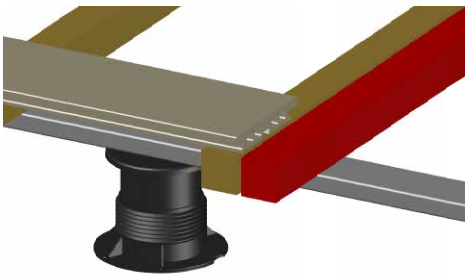

iJack (only for DURO/DURO Excellence)

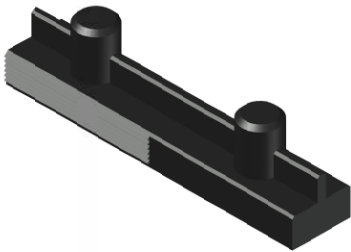

iJack was developed to overcome one of the issues of composite decking expansion & contraction by locking the ends of each board together to the gap stays constant. Though optional, the use of iJack is vividly suggested

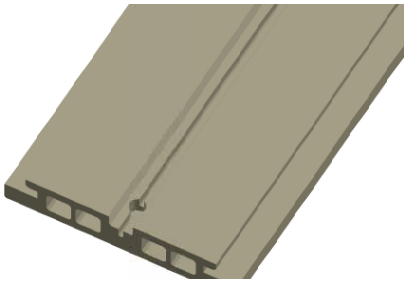

Duro Excellence boards are already drilled on the underside in preparation of taking the iJack

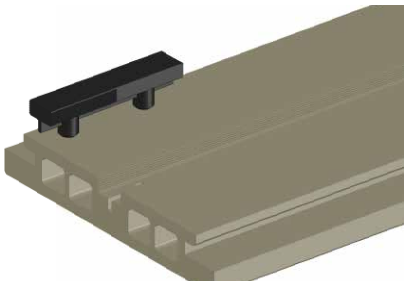

Turn the Duro board and click the iJack into the pre-drilled hole, pay attention to leave the flat sides of the iJack out.

Then turn the board and place it.
Go on with the rest of the boards if necessary.

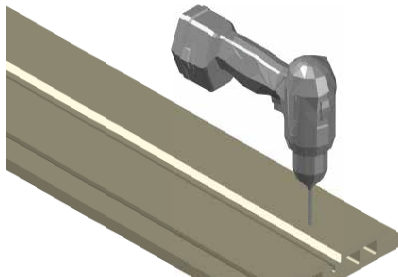
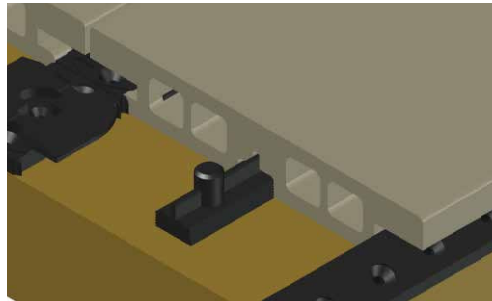
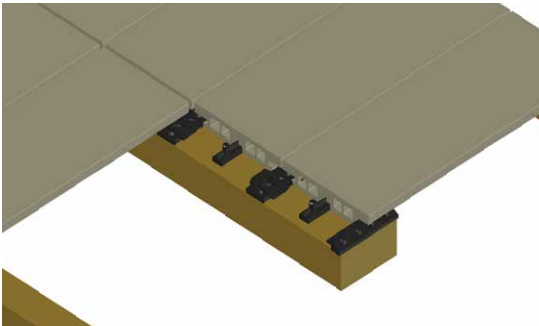

ATTENTION: In case a board is cut more than one time, it's possible to re-create the iJack hole drilling the board in the length direction at 17mm from the edge with a 10mm drill bit.

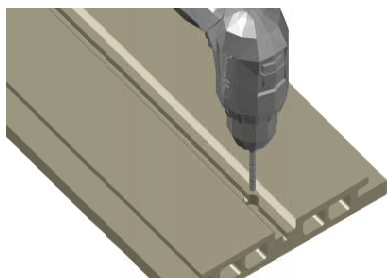

clip partenza/fine lavoro



Start/End clip is made of Nylon and it's commonly used at the beginning or very end of the deck.

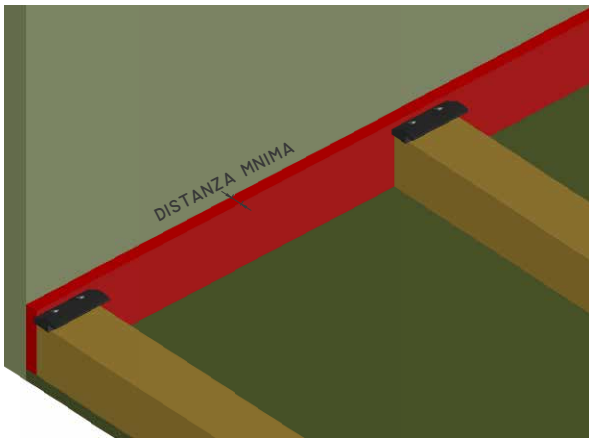

Always leave 20mm from the wall if there's any.

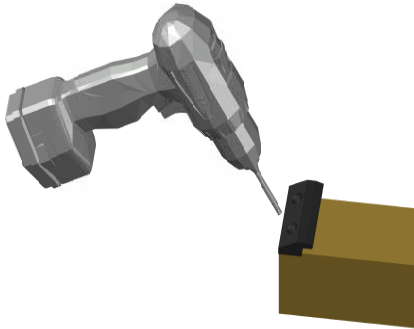

For a correct installation of the start/end clip, we recommend to pre-drill the holes before putting the screw.

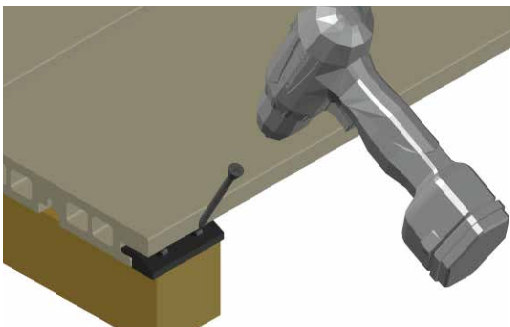

End the installation with the start/end clip.

Cut the board according to the space left.

Whether the deck is not ending with a full board, it won't be possible to use the start/end clip. It's necessary to cut the board according to the space left and fix it with a screw or glue for outdoor use.

iFly KEY - (unlocks/locks the board)



EasyChange Key is needed to lock and unlock the boards. Both during and after the installation.

So it's important to keep it safe.

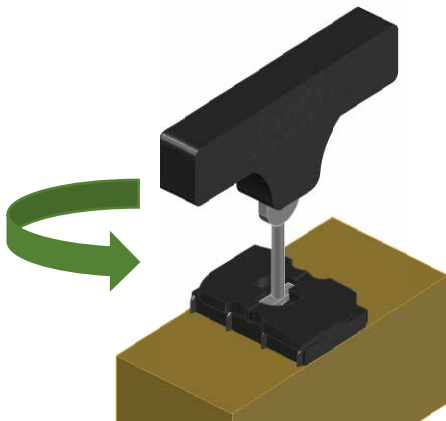
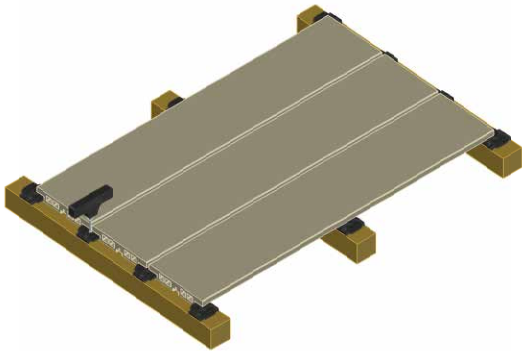

Turn the EasyChange key counterclockwise to unlock the board.

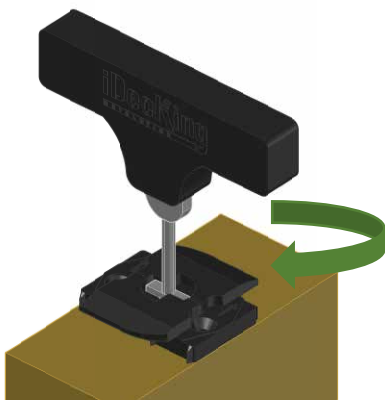

Turn the EasyChange clockwise to lock the board again.

framing profiles

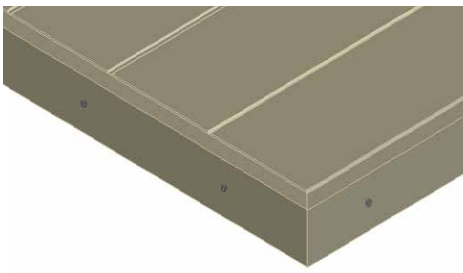

Framing profiles (both Duro and Bamboo) can be used all over the deck perimeter

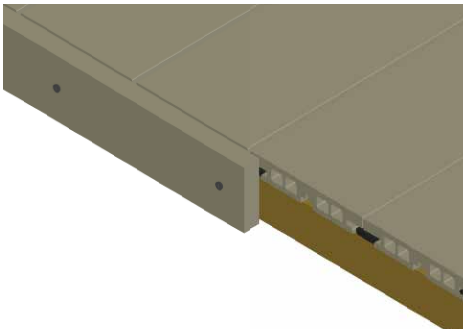

To fix it along the rail side, you can screw it directly to the substructure.

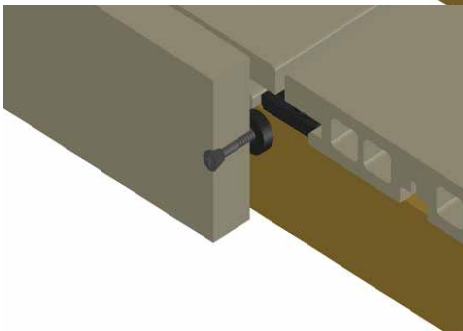

Use 5mm spacers for all the screws.

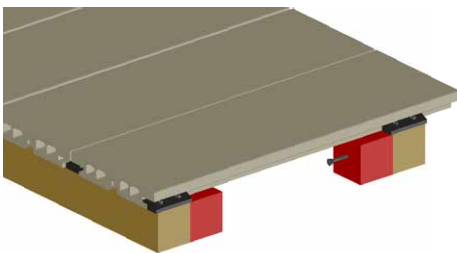

To fix the other side, you can use some pieces of rail to create a fixing point. Screwing it by the side with suitable screws (according to the substructure material).

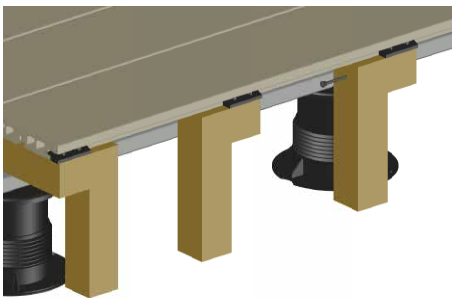

Height of the profile depends on the desired final height



Numbers of framing profiles depends on the side height to be covered.

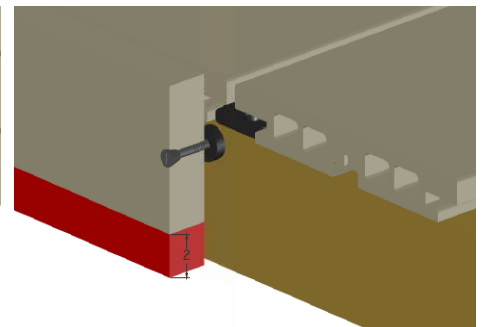

In all cases make sure to leave at least 2 cm air in order to allow ventilation and drainage.

Maintenance requirements for iDecking

Before, **use**

Apply 1 coat of DURO SHIELD preferably before or during installation.

If done after the installation, make sure to deep clean it with DURO CLEANER and then apply the coats of DURO SHIELD.

Once the deck is clean and treated with DURO SHIELD, use DURO DROP applying it with a rag or sponge and allow to dry.

This treatment makes the deck easier to clean and slows down the rate of fade.

Regular, **maintenance**

CLEAN THE DECK:

Use DURO CLEANER to wash the dirt from the deck. The deck can also be cleaned with a high pressure hose. Dilute DURO Cleaner in water (3 capfuls in 1 litre of water). Wash the floor with a well wrung out cloth. Rinse free. Recommended frequency: 15 days.

PROTECTOR:

Once the deck is clean, use DURO DROP applying it with a rag or sponge and allow to dry. Using DURO DROP protects the deck from stains and everyday grime. This can be re-applied regularly. As it is a more fluid material than DURO SHIELD, it is applied much easier and delivers a higher yield. For DURO DROP to work correctly, the boards have to have been protected with DURO SHIELD.

OIL/FAT SPOTS:

For persistent fat/oil spots apply the DURO INTENSIVE CLEANER SPRAY. Shake well DURO Intensive Cleaner before the use. Spray it directly on the spots that have to be removed, keeping a 25 cm distance. Let the product act for at least 2-3 minutes than brush and rinse with water. In case of tough dirt, re-apply DURO INTENSIVE CLEANER following the same procedure. The subsequent protective treatment can be performed with DURO DROP



www.idecksystems.com