

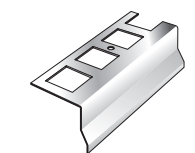

PROTEC CPB

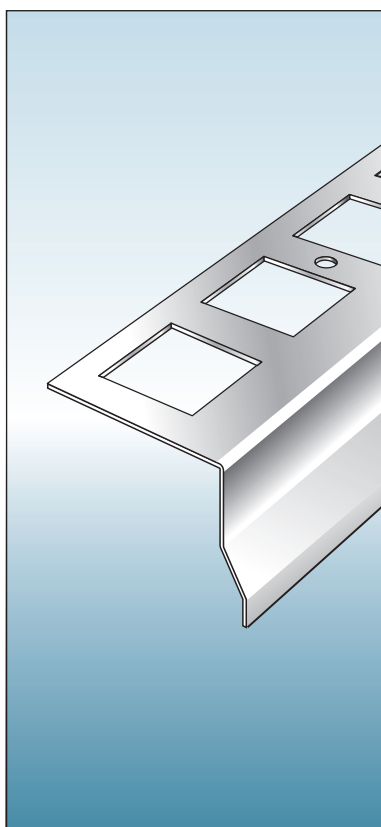

Length cm. 270

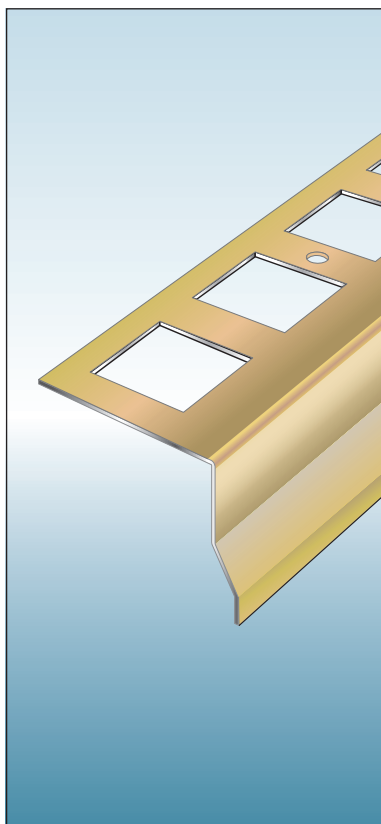
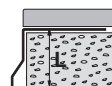

L = 55 mm

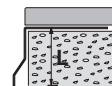

L = 75 mm



L = 95 mm

Pack.

IP

		ART.	CPBI/55	CPBI/75	CPBI/95		
STAINLESS STEEL 1.4301	ART.		CPBI/55	CPBI/75	CPBI/95		
	CODE		87372	87374	87376	10	100
	€/m						
	€/pc.						
COATED ALUMINIUM	ART.		CPBV/55	CPBV/75	CPBV/95		
	RAL 9010		87312	87314	87316		
	RAL 1019		87322	87324	87326		
	RAL 7038		87332	87334	87336		
	RAL 8019		87342	87344	87346	10	100
	RAL 8003		87352	87354	87356		
	€/m						
	€/pc.						
CORNERS 90° - STAINLESS STEEL 1.4301	ART.		CPBI/55E	CPBI/75E	CPBI/95E		
	CODE		87502	87504	87506	5	50
	€/pc.						
JUNCTIONS - STAINLESS STEEL 1.4301	ART.		CPBI/55G	CPBI/75G	CPBI/95G		
	CODE		87512	87514	87516	5	50
	€/pc.						
CORNERS 90° - COATED ALUMINIUM	ART.		CPBV/55E	CPBV/75E	CPBV/95E		
	RAL 9010		87382	87384	87386		
	RAL 1019		87392	87394	87396		
	RAL 7038		87402	87404	87406	5	50
	RAL 8019		87412	87414	87416		
	RAL 8003		87422	87424	87426		
	€/pc.						
JUNCTIONS - COATED ALUMINIUM	ART.		CPBV/55G	CPBV/75G	CPBV/95G		
	RAL 9010		87442	87444	87446		
	RAL 1019		87452	87454	87456		
	RAL 7038		87462	87464	87466	5	50
	RAL 8019		87472	87474	87476		
	RAL 8003		87482	87484	87486		
	€/pc.						

Price per metre is indicative. Partial Packaging: 10% supplement.
Corners and Junctions: partial packages not available.

PROTEC CPC

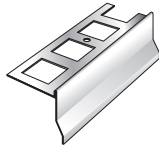
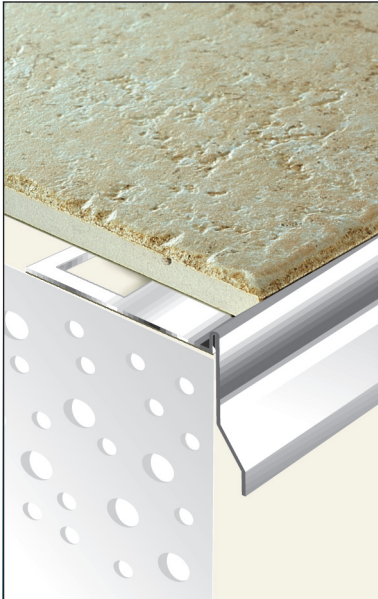
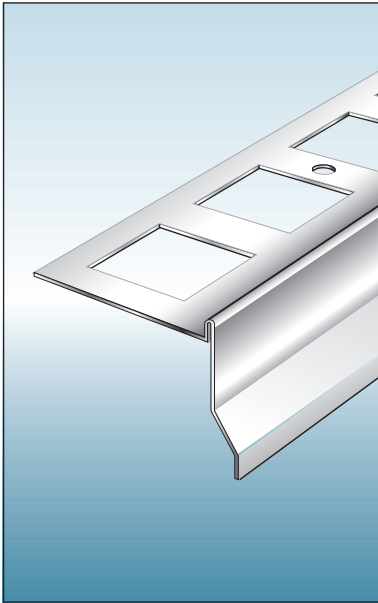

Length cm. 270

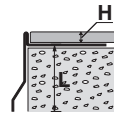

L = 55 mm

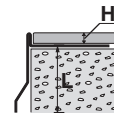

L = 75 mm

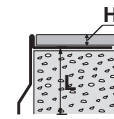

L = 95 mm

Pack. IP

STAINLESS STEEL 1.4301	ART.	CPCI/55	CPCI/75	CPCI/95	10	100
	CODE	87671	87673	87675		
	€/m					
	€/pc.					
H = 10 mm						
CORNERS 90° - STAINLESS STEEL 1.4301	ART.	CPCI/55E	CPCI/75E	CPCI/95E	5	50
	CODE	87801	87803	87805		
	€/pc.					
JUNCTIONS - STAINLESS STEEL 1.4301	ART.	CPCI/55G	CPCI/75G	CPCI/95G	5	50
	CODE	87811	87813	87815		
	€/pc.					
STAINLESS STEEL 1.4301	ART.	CPCI/55	CPCI/75	CPCI/95	10	100
	CODE	87672	87674	87676		
	€/m					
	€/pc.					
H = 12,5 mm						
CORNERS 90° - STAINLESS STEEL 1.4301	ART.	CPCI/55E	CPCI/75E	CPCI/95E	5	50
	CODE	87802	87804	87806		
	€/pc.					
JUNCTIONS - STAINLESS STEEL 1.4301	ART.	CPCI/55G	CPCI/75G	CPCI/95G	5	50
	CODE	87812	87814	87816		
	€/pc.					

Price per metre is indicative. Partial Packaging: 10% supplement.
Corners and Junctions: partial packages not available.



PROFESSIONAL SPACERS

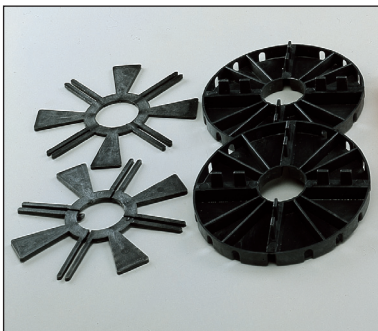

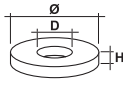

	MEASURES L x H	ARTICLE	CODE	€/pack.	Pack.	Box pack.
CROSS SPACERS	2 x 5*	DC2	19000		250	20
	3 x 5	DC3	19006			
	4 x 5	DC4	19012			
	5 x 5	DC5	19018			
	7 x 6	DC7	19024			
	10 x 8	DC10	19030			
250 pcs package						
CROSS SPACERS	MEASURES L x H	ARTICLE	CODE	€/pack.	500	10
	2 x 5*	DC2	19002			
	3 x 5	DC3	19008			
	4 x 5	DC4	19014			
	5 x 5	DC5	19020			
	7 x 6	DC7	19026			
10 x 8	DC10	19032				
500 pcs package						
"T" SPACERS	MEASURES L x H	ARTICLE	CODE	€/pack.	250	20
	2 x 5*	DT2	19040			
	3 x 5	DT3	19046			
	4 x 5	DT4	19052			
	5 x 5	DT5	19058			
	7 x 6	DT7	19064			
10 x 8	DT10	19070				
250 pcs package						
"T" SPACERS	MEASURES L x H	ARTICLE	CODE	€/pack.	500	10
	2 x 5*	DT2	19042			
	3 x 5	DT3	19048			
	4 x 5	DT4	19054			
	5 x 5	DT5	19060			
	7 x 6	DT7	19066			
10 x 8	DT10	19072				
500 pcs package						
WEDGES	MEASURES L x l x H	ARTICLE	CODE	€/pack.	250	20
	9 x 28 x 5	CN28	19080			
	9 x 28 x 5	CN28	19082		500	10
LEVELLERS FOR BEARINGS	 MEASURES Ø x H x D	ARTICLE	CODE	€/pack.	100	4
	150 x 3 x 4	SP2	19092			
BEARINGS FOR FLOATING FLOORS	150 x 14 x 4	SP1	19090		250	1

* Solid crosses and "T" spacers. Partial packages not available.

NEW: Available 1 mm cross spacers **DC/1** code 18992 €/pack. pack. 500 pc.
1 mm "T" spacers **DT/1** code 19038 €/pack. pack. 500 pc.

BRICO SPACERS

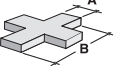
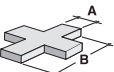

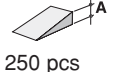
	MEASURES A X B (mm)	THICKNESS (mm)	ARTICLE	CODE	€/pack.	Pack.	Box pack.
CROSS SPACERS 	1,5 x 18	2,1	DC2315	18000		250	20
	2 x 18	3	DC2302	18002			
	3 x 18	3	DC2303	18004			
	4 x 28	3,5	DC2304	18006			
	5 x 28	4,5	DC2305	18008			
	6 x 28	3,5	DC2306	18010			
	8 x 28	5	DC2308	18014			
250 pcs package							
CROSS SPACERS 	MEASURES A X B (mm)	THICKNESS (mm)	ARTICLE	CODE	€/pack.	500	10
	1,5 x 18	2,1	DC2515	18001			
	2 x 18	3	DC2502	18003			
	3 x 18	3	DC2503	18005			
500 pcs package	4 x 28	3,5	DC2504	18007			
"T" SPACERS 	MEASURES A = mm	THICKNESS mm	ARTICLE	CODE	€/pack.	250	10
	4	3	DT3304	18040			
	5	5	DT3305	18042			
250 pcs package	8	5	DT3308	18050			
WEDGES 	MEASURES A = mm		ARTICLE	CODE	€/pack.	250	10
	5		CN4305	17098			
250 pcs package							

BRICO PRO SPACERS

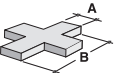
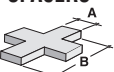

	MEASURES A X B (mm)	THICKNESS (mm)	ARTICLE	CODE	€/pack.	Pack.	Box pack.
CROSS SPACERS 	2 x 28	3	DC1302	18020		250	10
	3 x 28	3	DC1303	18022			
	4 x 28	3	DC1304	18024			
	5 x 28	5	DC1305	18026			
	6 x 28	5	DC1306	18028			
	8 x 28	5	DC1308	18032			
250 pcs package							
CROSS SPACERS 	MEASURES A X B (mm)	THICKNESS (mm)	ARTICLE	CODE	€/pack.	500	10
	2 x 28	3	DC1502	18021			
	3 x 28	3	DC1503	18023			
500 pcs package	4 x 28	3	DC1504	18025			

* Solid crosses and "T" spacers. Partial packages not available.



MAGNETIC KIT

K10 is a kit composed by magnetic latches and punched counter plates for the realization of easily removable inspection panels (for example in baths).

Each kit is composed by 4 magnetic latches and 4 counter plates.

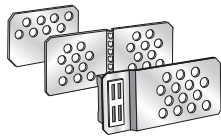

ART.	CODE	€/blister	Pack.	IP
K10 Magnetic Kit	00410	(blister 1 pc.)	10 blister	120

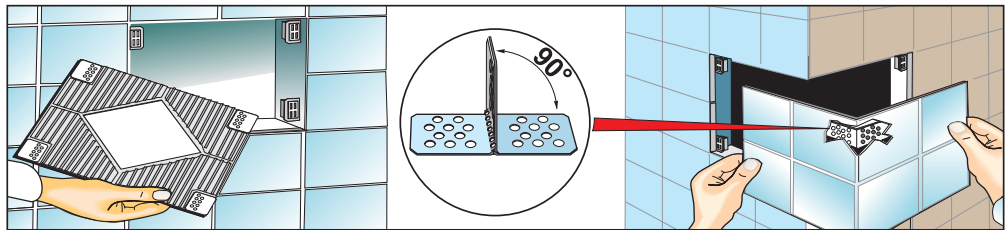

SANIBORD B/11

SANIBORD B/11 is a joint covering in self-adhesive PVC for the protection and the finish of corners between walls and sanitary fittings, tops in bathrooms and in kitchens. Easy to clean, SANIBORD assures hygiene in places particularly subject to dirt and moisture.

**PVC
PURE WHITE
RAL 9010**

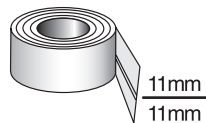

Length cm. 350

ART.	CODE	€/blister	Pack.	IP
B/11 Self-adhesive	30020	(blister 1 pc.)	12	120

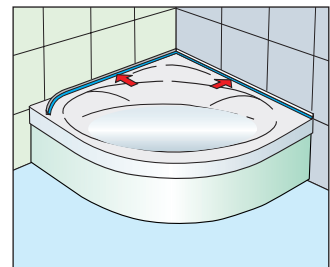
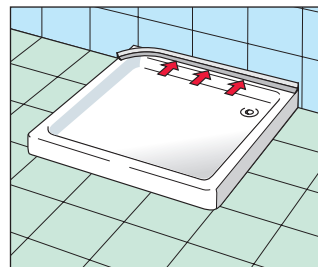
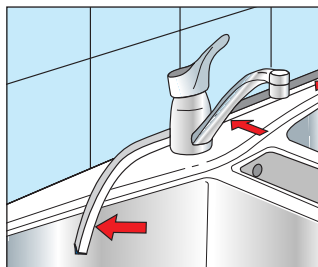

GLUES

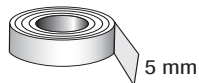

PP/46 is a butyl glue used for the gluing of the Sanibord profiles (pag. 12) with sanitary fittings and tiles. Delivered in rolls, it is used also as protection in case of water infiltrations.

ART.	CODE	€/	Pack.	IP
PP/46 Tape of white butyl glue Rolls from 27 m	78301	(roll)	15 rolls	720

PP/56 is a neutral elastic silicone, recommended for the gluing of the Sanibord profiles (pag. 12) with sanitary fittings and tiles.

TRANSPARENT



PP/56 Silicone for the laying of Sanibord profiles. ml 310	78302	(cartridge)	25	1200
---	-------	-------------	----	------

Partial packages not available.

NON-SLIP STRIP Safety Walk



ART.	WIDTH (mm)	LENGHT (cm)	CODE	€/pc.	Pack.	I.P.
BLACK	19	61	23000		50	500
	25	61	23001			
TRANSPARENT	19	61	23016		50	500
BROWN	19	61	23060			
WHITE	19	61	23032			
GREY	19	61	23040			
BLACK	19	1820	23002			
TRANSPARENT	19	1820	23018		4	80 rolls
BROWN	19	1820	23062			
WHITE	19	1820	23034			
GREY	19	1820	23042			
BLACK	25	1820	23004			
TRANSPARENT	25	1820	23020		4	80 rolls
BROWN	25	1820	23064			
WHITE	25	1820	23036			
GREY	25	1820	23044			
BLACK	50	1820	23006			
TRANSPARENT	50	1820	23022		2	40 rolls
BROWN	50	1820	23066			
WHITE	50	1820	23038			
GREY	50	1820	23046			
PRIMER EC 1236		cc 150 Rendering: 1 square m	23180		12	
SEALER EC 1103		cc 148 Rendering: 8 m	23184		36	

Partial packages not available.
NON-SLIP RANGE at page 112

MITRE CUTTER

K20 is a mitre cutter for PVC profiles to realize cuts from 45° up to 90°. Its blade is interchangeable.

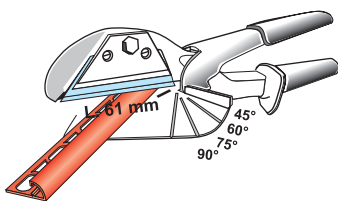

ART.	€/blister	Pack.	IP
K20 Mitre Cutter	(blister 1 pc.)	10 blister	100
B/2171 Spare blade		100	

PRO FLEX LINE

Proflex Line is a range of bendable profiles for the laying of floor coverings in ceramic, wood, laminate, parquet, etc.

This line includes edge trims, profiles for differences in levels, separation and dilatation joints all easily bendable and adaptable to the curves of the floors, thanks to the special punching of the base and to the use of the Proflex Machine.

PROANGLE FLEX

Bendable profile used to join ceramic, parquet and carpet floors.

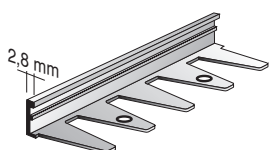

Length cm. 270



H = mm

	ART.	H (mm)	CODE	€/m	€/pc.	Pack.	IP
NATURAL BRASS	ZNF/30	3	88701			20	200
	ZNF/45	4,5	88702				
	ZNF/60	6	88703				
	ZNF/80	8	88704				
	ZNF/100	10	88705				
	ZNF/125	12,5	88706				
	ZNF/150	15	88707				
	ZNF/175	17,5	88708				
	ZNF/200	20	88709				
	ZNF/225	22,5	88710				
	ZNF/250	25	88711				
	ZNF/275	27,5	88712				
ZNF/300	30	88713			10		
POLISHED STAINLESS STEEL 1.4301	AIF/60	6	91622			10	200
	AIF/80	8	91623				
	AIF/100	10	91624				
	AIF/125	12,5	91625				
NATURAL ALUMINIUM	ZGF/30	3	88720			20	200
	ZGF/45	4,5	88721				
	ZGF/60	6	88722				
	ZGF/80	8	88723				
	ZGF/100	10	88724				
	ZGF/125	12,5	88725				
	ZGF/150	15	88726				
	ZGF/175	17,5	88727				
	ZGF/200	20	88728				
	ZGF/225	22,5	88729				
	ZGF/250	25	88730				
	ZGF/275	27,5	88731				
ZGF/300	30	88732			10		

Price per metre is indicative. Partial Packaging: 10% supplement.

PRODECOR FLEX

Bendable profile used for the junction of floors.

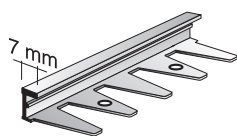

Length cm. 270

H = mm

1

NATURAL BRASS	ART.	H (mm)	CODE	€/m	€/pc.	Pack.	IP
	DNF/80		8	95630			20
DNF/100		10	95631				
DNF/125		12,5	95632				
ANODISED ALUMINIUM SILVER	DAF/80	8	95950			20	200
	DAF/100	10	95951				
	DAF/125	12,5	95952				

PROTRIM FLEX

Bending edge profiles.

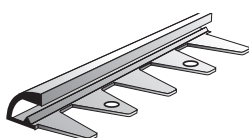

Length cm. 270

H = mm

1

NATURAL BRASS	ART.	H (mm)	CODE	€/m	€/pc.	Pack.	IP
	RNF/8		8	92476			10
RNF/10		10	92478				
ANODISED ALUMINIUM SILVER	RAF/8	8	92082			10	200
	RAF/10	10	92084				

JOINT FLEX

Bendable joint coverings.

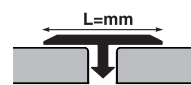
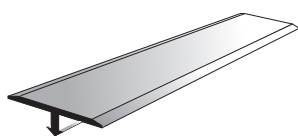

Length cm. 270

L = mm

1

POLISHED BRASS	ART.	L (mm)	CODE	€/m	€/pc.	Pack.	IP
	399/T		14	75087			50
399/T20		20	75090			30	
399/T26		26	75088			20	100
POLISHED CHROMIUM-PLATED BRASS	399/TC	14	75086			30	200
	399/T26C	26	75089			20	100
ANODISED ALUMINIUM SILVER	99/T	14	75080			50	200
	99/T26	26	75082			20	100

Price per metre is indicative. Partial Packaging: 10% supplement.

PRO FLEX LINE

TERMINAL FLEX

Bendable edge profile.

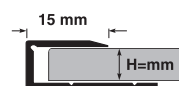
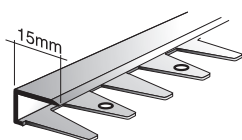

Length cm. 270

		H = 7 mm	H = 9 mm	H = 11 mm	H = 15 mm	H = 22,5 mm	Pack.	IP
ANODISED ALUMINIUM	ART.	RCF/7	RCF/9	RCF/11	RCF/15	RCF/22		
	SILVER	67710	67712	67714	67718	67722		
	GOLD	67711	67713	67715	67719	67723		
	€/m							
	€/pc.							
ALCROM PLUS DECORATED ALUMINIUM	ART.		RCF/9		RCF/15		10	100
	10		67509		67649			
	15		67511		67651			
	20		67513		67653			
	40		67515		67655			
	45		67517		67657			
	48		67519		67659			
	50		67521		67661			
	60		67523		67663			
	65		67525		67665			
	70		67527		67667			
	75		67529		67669			
	80		67531		67671			
	90		67533		67673			
€/m								
€/pc.								

Z3/30



NATURAL ALUMINIUM BASE

Length cm. 270

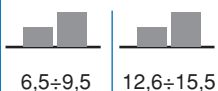

	TPUF/6	TPUF/13
ART.	TPUF/6	TPUF/13
CODE	67439	67459
€/m		
€/pc.		
Pack.	20	20
IP	100	100

The price of the bases includes 15 clips

TU/6 CLIPS
COD. 68812 €/pack.

Packages 150 pcs. Partial packages not available.

		Z3/30	€/m	€/pc.	Pack.	IP
ANODISED ALUMINIUM SILVER		Z3/30				
		63700				
ALCROM PLUS DECORATED ALUMINIUM		Z3/30			10	100
	09	63719				
	10	63720				
	15	63721				
	20	63725				
	40	63730				
	42	63731				
	45	63732				
	48	63735				
	50	63740				
	60	63745				
	65	63746				
70	63747					
75	63748					
80	63750					
90	63751					

Length cm. 270

Price per metre is indicative. Partial Packaging: 10% supplement.

Art. Z2/20

Bendable joining profile.

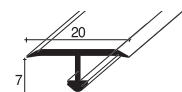

	ART.	FINISH	CODE	€/m	€/pc.	Pack.	IP
ANODISED ALUMINIUM SILVER Z2/20SF Length cm. 270			63600			1 20	200
	ALCROM PLUS DECORATED ALUMINIUM Z2/20SF Length cm. 270	10	63620			1 10	200
20		63625					
40		63630					
48		63635					
50		63640					
60		63645					
80		63650					

PRONIVEL FLEX

(Patented Profile). It is a bendable edge profile for ceramic, parquet and laminated floors. It allows the perfect junction between two floors at different levels.

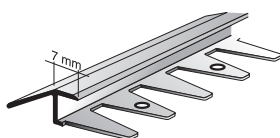

Length cm. 270

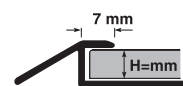

H = mm

	ART.	H (mm)	CODE	€/m	€/pc.	Pack.	IP
NATURAL BRASS	PLMF/8	8	93200			1 10	200
	PLMF/10	10	93202				
ANODISED ALUMINIUM SILVER	PLAF/8	8	93190			1 10	200
	PLAF/10	10	93192				

Price per metre is indicative. Partial Packaging: 10% supplement.

PROFLEX MACHINE

Professional machine designed to bend and adapt all the profiles of the Flex Line to the curves of the floors.

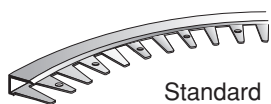

Kit with 3 wheels for RCF/11, RCF/15 and RCF/22

Kit with 4 wheels for PLMF and PLAF

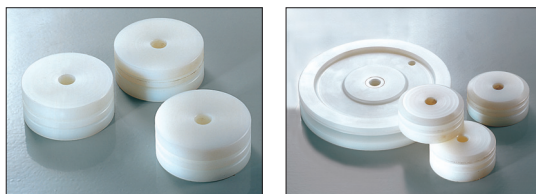
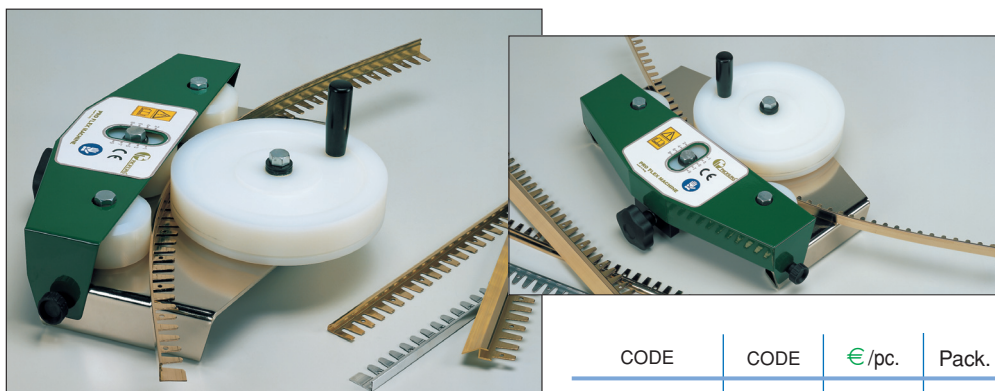

CODE	CODE	€/pc.	Pack.
Flex Machine	30022		1
Kit with 3 wheels	30043		1
Kit with 4 wheels	30044		1